



Furniture Catalogue
VOL 15 2019

WORKSTATIONS - FURNITURE - SEATING - STORAGE - ACCESSORIES
WWW.RAPIDLINE.COM.AU

rapidline
FURNITURE FOR TODAY



This catalogue aims to provide a comprehensive furniture range from which you can completely furnish your office.

All products are selected from Sedex compliant factories around the globe and supported by full commercial warranties.

Our Product Development team strives to establish and maintain high quality standards and selects recognised certified bodies such as Afrdi, Bifma, FSC and Greenguard with as many products as possible.

Rapidline product is supported by:

- Privately-owned and managed distribution centres across Sydney, Melbourne, Brisbane and Perth
- Full delivery and installation service
- National customer service teams
- In house marketing and projects team
- Design and layout service

CONTENTS

VOLUME 15

4 - 9	Reception & Lounge	66 - 69	Operator Chairs
10 - 16	Rapid Infinity	70 - 71	Visitor Chairs
17	Cable Management	72 - 75	Executive Chairs
18 - 23	Rapid Screen	76 - 79	Events & Hospitality Seating
24 - 27	Rapid Span White	80 - 83	Accessories
28 - 31	Rapid Span Beech	84 - 85	Whiteboards, Glassboards, Pinboards & Corkboards
32 - 37	Tables		
38 - 44	Height Adjustable Desks	86	Personal Storage
45	Monitor Arms	87	Filing Cabinets
46 - 49	Rapid Vibe	88	Tambour Door Cupboards
50 - 53	Rapid Worker	89	Steel Storage
54 - 57	Rapid Manager	90	Mobile Shelving
58 - 65	Mesh Chairs	91	Lockers

Reception & Lounge



RECEPTION & LOUNGE

The reception area sets the tone of your business for your clients. Make the best possible first impression with a fresh, professional, stylish counter whilst allowing your visitors to wait in comfort and style with a range of fantastic soft seating designs.

- Range of sizes to suit any reception space small or large
- Available in a range of colours to match any decor
- 5 Year Warranty
- Choose from stylish lounges to comfortable single seating options for your visitors.

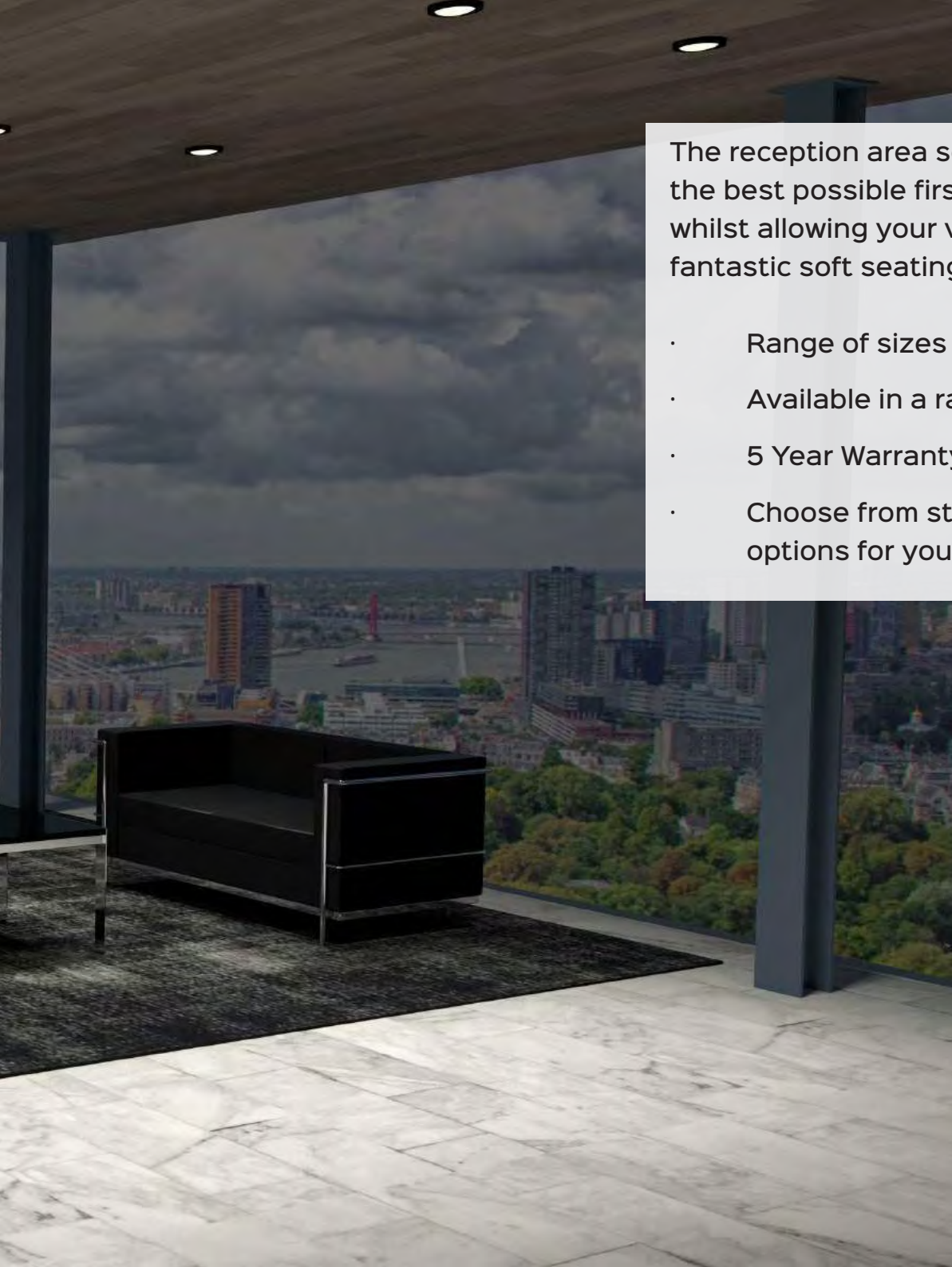

RECEPTION & LOUNGE

URBAN RECEPTION COUNTER



NEW

Urban Reception Counter · Brilliant White with Driftwood Wrap Around Cowl Feature Panel, Built In 3 Drawer Under-desk Pedestal, CPU & Storage Cupboard with 2 x Chrome Cable Entry Hole Covers
URC BW / DW · 2200mm W x 800mm D x 1150mm H



Brilliant White /
Driftwood

MODULAR RECEPTION COUNTER

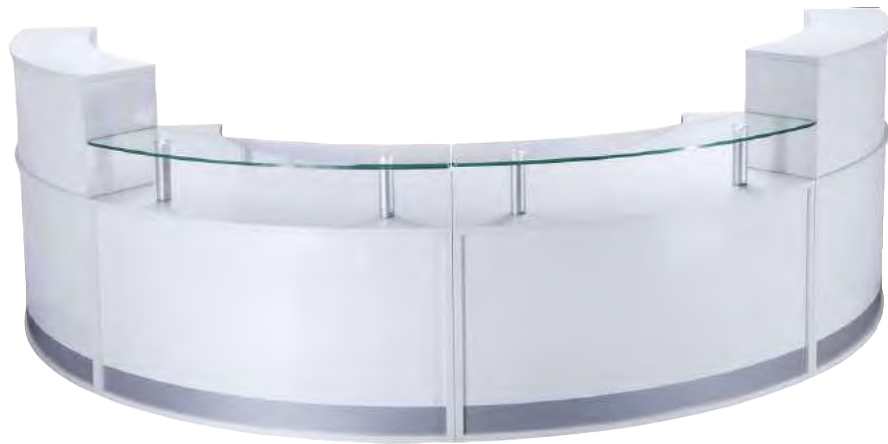

Modular Reception Counter · Warm White Modular Reception Counter Comprised of 2 Mix and Match Units
MOD1W · Full Height Module 1339mm W x 872mm D x 1160mm H
MOD1W · Glass Top Module 1339mm W x 872mm D x 935mm H



Warm White

MARQUEE RECEPTION COUNTER



NEW

Marquee Reception Counter · Gloss White Veneer with Zebra Veneer Front Columns, Glass Top, 2 x Chrome Cable Entry Hole Covers with Brush Insulators, Built In 3 Drawer Under-desk Pedestal, CPU & Storage Cupboard
MRC GW / ZB · 2400mm W x 835mm D x 1150mm H



Gloss White /
Zebra

RC1809 RECEPTION COUNTER



NEW

RC1809 Reception Counter · Brilliant White Counter with Black Powdercoat Cowl Featuring Cut Out Pattern and Matching Kickplate
RC1809 · 1800mm W x 800mm D x 1170mm H



Brilliant White /
Black Powdercoat

FLOW RECEPTION COUNTER



Flow Reception Counter · Curved Reception Counter with Glass Feature on Side and High Reception Hob for Privacy
NCT1160 · 2400mm x 1600mm x 800mm D



Beech

NEW

THE 5-O RECEPTION COUNTER



The 5-O Reception Counter · Gloss White Veneer All Over Reception Counter with Chrome Trim Detail on Front Panel
 2 x Chrome Cable Entry Hole Covers with Brush Insulators
RC5-O GW · 2400mm W x 848mm D x 1100mm H



Gloss White

RAPID BLOOM VERTICAL GARDEN



NEW



White



Black

RAPID BLOOM · Bring Nature into the Office with a Vertical Garden, Available in Black or White, with 8 x 150mm Diameter Round Pots and 20kg of Polished Stones
SRBVG BK · **SRBVG WH** · 395mm W x 210mm D x 1940mm H · Plants Not Included

First Impressions count.
 Ask us to design your new reception area.



RECEPTION & LOUNGE

SPLASH CONE



SPLASH CONE · Comfortable Circular Seat with Chrome Cross Base
SW 500mm · SD 510mm · BH 430mm

SPLASH CLUB



SPLASH CLUB · Tub Style Lounge Chair with Gas Height Adjustment
SW 480mm · SD 500mm · GH 460-590mm

SPLASH CUBE



SPLASH CUBE · Contemporary Style Chair with Chrome Sled Base
SW 460mm · SD 520mm · BH 320mm

SPACE TUB 1



SPTUB1 · Compact Modern Chair for Small Spaces in Black PU Finish
SW 540mm · SD 430mm · BH 370mm

SPACE 1



SPACE 1 · Soft Black PU Finish Seat with Stylish Chrome Frame Detail
SW 550mm · SD 515mm · BH 310mm

SPACE 2



SPACE 2 · Ideal for Comfortable Seating in Reception, Meeting and Breakout Areas, Black PU Material
SW 1110mm · SD 515mm · BH 310mm

SPACE 3



SPACE 3 · Soft Black PU Material for Easy Cleaning and Maintenance, Stylish Wraparound Frame Feature, Spacious 3 Seater Design
SW 1670mm · SD 515mm · BH 310mm

ROUND COFFEE TABLE

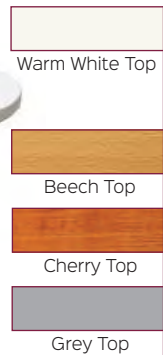

CCT6 · Round 600mm Diameter Coffee Table with Round Chrome Base
600mm DIA. x 425mm H

BUDGET COFFEE TABLE



CT96 · Budget Coffee Table
Beech Top with Ironstone Base
900mm W x 600mm D x 450mm H

BLACK GLASS COFFEE TABLE



Black Glass and Chrome Frame Coffee Table
AGT66 · 600mm W x 600mm D x 450mm H
AGT126 · 1200mm W x 600mm D x 450mm H

RAPID 50 COFFEE TABLE



R50CT · Modern Rectangular White Coffee Table with 50mm Frame
1200mm W x 600mm D x 450mm H

Choose from a range of stylish lounges and occasional chairs to suit any space.

Chair Dimension Codes

SW · Seat Width

SD · Seat Depth

BH · Back Height

SH · Seat Height

GH · Gas Height Range



SPACE EXECUTIVE TUB



SP EXEC TUB · Large Comfortable Tub Chair, Flared Armrest Detail, Black PU
SW 480mm · SD 470mm · BH 390mm

VENUS OTTOMAN



VENUS OTOMAN · Use as an Ottoman or as a Foot Stool to Match All Venus Lounges
SW 1030mm · SD 540mm · BH 410mm

VENUS 1



VENUS 1 · Black Classic Designed Seat with Distinctive Button Finish
SW 630mm · SD 500mm · BH 400mm

VENUS 2



VENUS 2 · Ideal for Reception or Meeting Areas with Black PU Upholstery
SW 1120mm · SD 500mm · BH 400mm

VENUS 3



VENUS 3 · Easy to Clean Black PU Finish, Pair with Matching Venus Ottoman for the Ultimate Professional Waiting Area or Lounge Space
SW 1770mm · SD 500mm · BH 400mm

ENTERPRISE 1



ENT1 BU · Comfortable Blue Fabric Upholstery and Chrome Sled Base
SW 530mm · SD 510mm · BH 320mm

ENTERPRISE 2



ENT2 BU · Modern Sled Base, Blue 2 Seater Lounge for Breakout Areas, Reception or Casual Meeting Rooms
SW 1010mm · SD 510mm · BH 320mm

ENTERPRISE 3



ENT3 BU · Spacious 3 Seater Design in Comfortable Blue Fabric, the Perfect Addition to Any Waiting Area or Inspiring Breakout Space
SW 1530mm · SD 510mm · BH 320mm

Rapid Infinity



Maximise floor space and leg room with the stylish Rapid Infinity bench workstation system. Choose between two different end leg styles and optional screens to create clean, space efficient workstation runs suitable for single, or large numbers of users.

- Choose from the profile or loop leg
- Select the loop end leg for a distinctive, premium finish
- Profile 60 x 30mm end leg creates simple, clean lines
- Double telescopic rail for rigid support
- Recessed intermediate leg for maximum leg space
- Pinnable black screen provides privacy whilst also reducing noise
- 5 Year Warranty

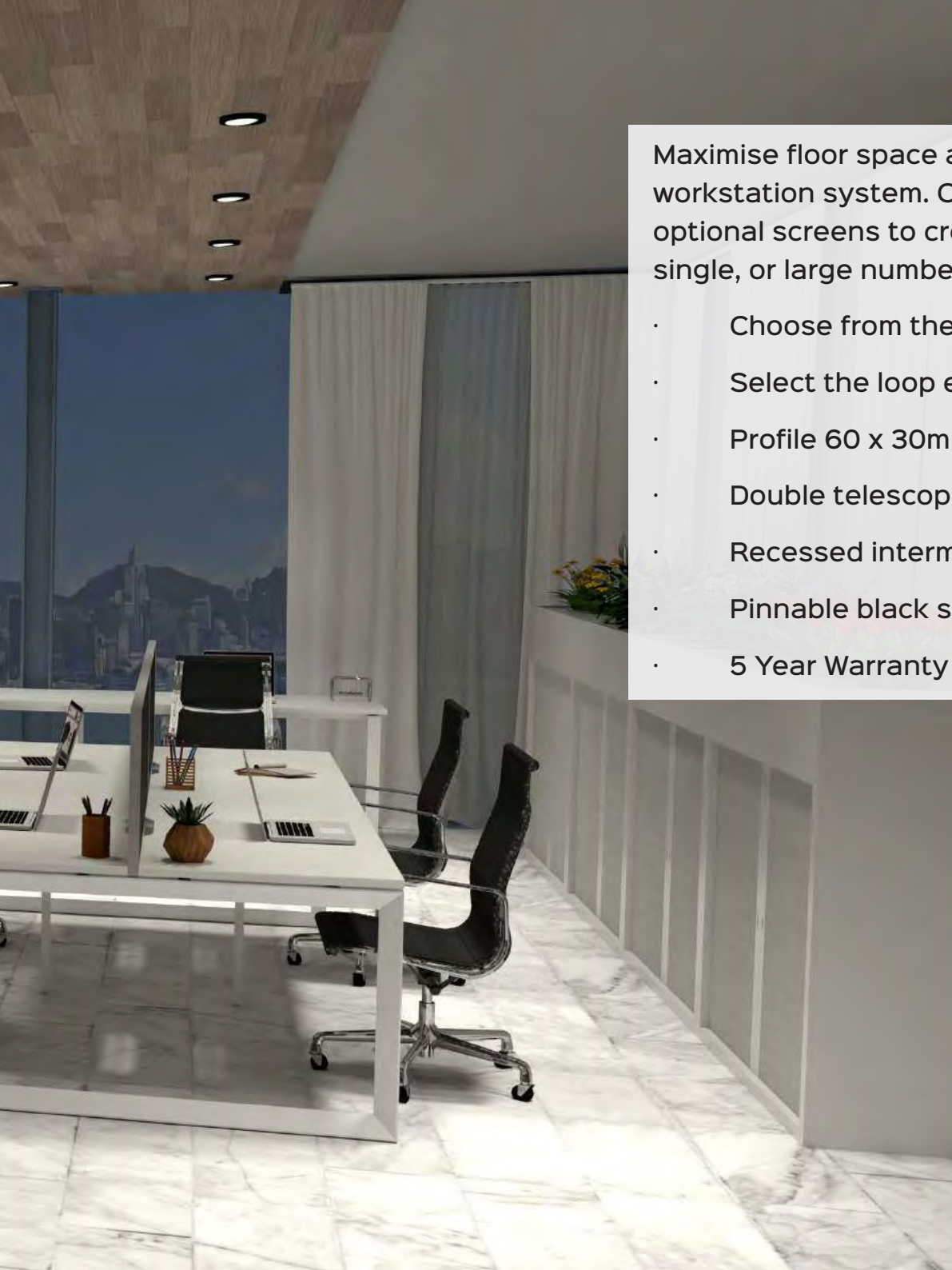

RAPID INFINITY



SINGLE SIDED WORKSTATION · PROFILE LEG



Profile Leg · Brilliant White Scalloped Top



Profile Leg · Beech Top with Cable Entry Holes



Profile Leg · Warm White Top with Cable Entry Holes
Top Sizes in Brilliant White, Beech or Warm White:
1200W x 700D · 1500W x 700D · 1800W x 700D

DOUBLE SIDED WORKSTATION · PROFILE LEG

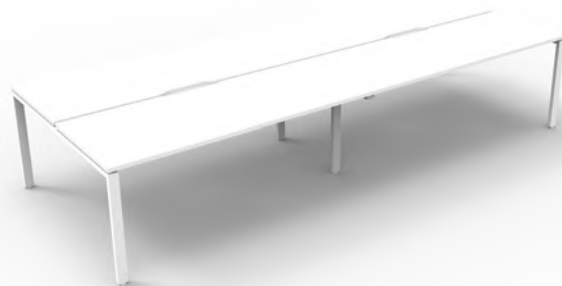

Profile Leg · Brilliant White Scalloped Top



Profile Leg · Beech Top with Cable Entry Holes



Profile Leg · Warm White Top with Cable Entry Holes
Top Sizes in Brilliant White, Beech or Warm White:
1200W x 700D · 1500W x 700D · 1800W x 700D

CORNER WORKSTATION · PROFILE LEG



Profile Leg · Warm White Corner Top with Cable Entry Holes



Profile Leg · Beech Corner Tops with Cable Entry Holes



Profile Leg · Top Sizes in Beech or Warm White:
1500W x 1800W x 700D · 1500W x 1500W x 700D
1800W x 1800W x 700D

NEW

NEW

NEW



Brilliant White Top



Beech Top



Warm White Top



White Frame



RAPID INFINITY

SINGLE SIDED WORKSTATION · LOOP LEG



Loop Leg · Brilliant White Scalloped Top



Loop Leg · Beech Top with Cable Entry Holes

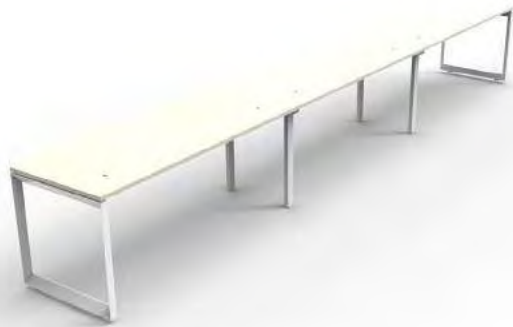

Loop Leg · Warm White Top with Cable Entry Holes
Top Sizes in Brilliant White, Beech or Warm White:
1200W x 700D · 1500W x 700D · 1800W x 700D

DOUBLE SIDED WORKSTATION · LOOP LEG

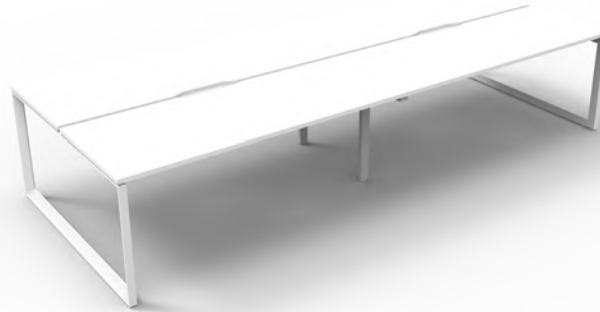

Loop Leg · Brilliant White Scalloped Top



Loop Leg · Beech Top with Cable Entry Holes



Loop Leg · Warm White Top with Cable Entry Holes
Top Sizes in Brilliant White, Beech or Warm White:
1200W x 700D · 1500W x 700D · 1800W x 700D

CORNER WORKSTATION · LOOP LEG

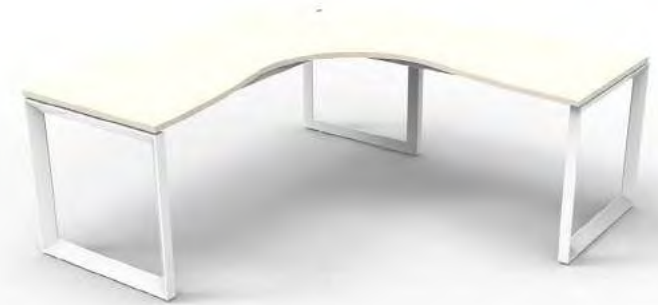

NEW

Loop Leg · Warm White Corner Top with Cable Entry Holes



NEW

Loop Leg · Beech Corner Tops with Cable Entry Holes



NEW

Loop Leg · Top Sizes in Beech or Warm White:
1500W x 1800W x 700D · 1500W x 1500W x 700D
1800W x 1800W x 700D

RAPID INFINITY WITH SCREENS

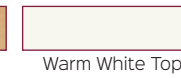

SINGLE SIDED WORKSTATION · PROFILE LEG WITH SCREENS



Profile Leg · Brilliant White Scalloped Top



Profile Leg · Beech Top with Cable Entry Holes



Profile Leg · Warm White Top with Cable Entry Holes
Top Sizes in Brilliant White, Beech or Warm White:
1200W x 700D · 1500W x 700D · 1800W x 700D

DOUBLE SIDED WORKSTATION · PROFILE LEG WITH SCREENS

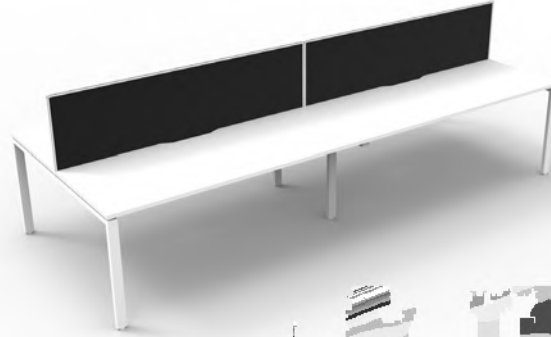

Profile Leg · Brilliant White Scalloped Top



Profile Leg · Beech Top with Cable Entry Holes



Profile Leg · Warm White Top with Cable Entry Holes
Top Sizes in Brilliant White, Beech or Warm White:
1200W x 700D · 1500W x 700D · 1800W x 700D

CORNER WORKSTATION · PROFILE LEG WITH SCREENS



Profile Leg · Warm White Corner Top with Cable Entry Holes



Profile Leg · Beech Corner Tops with Cable Entry Holes



Profile Leg · Top Sizes in Beech or Warm White:
1500W x 1800W x 700D · 1500W x 1500W x 700D
1800W x 1800W x 700D

NEW

NEW

NEW



RAPID INFINITY WITH SCREENS

SINGLE SIDED WORKSTATION · LOOP LEG WITH SCREENS



Loop Leg · Brilliant White Scalloped Top



Loop Leg · Beech Top with Cable Entry Holes

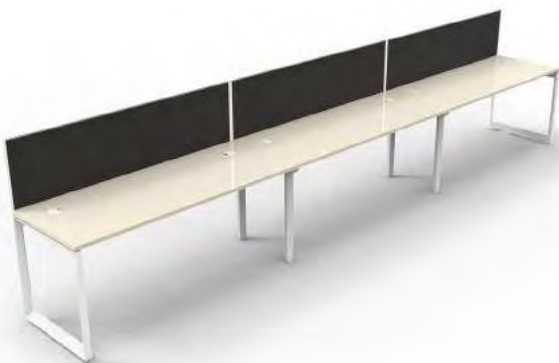

Loop Leg · Warm White Top with Cable Entry Holes
Top Sizes in Brilliant White, Beech or Warm White:
1200W x 700D · 1500W x 700D · 1800W x 700D

DOUBLE SIDED WORKSTATION · LOOP LEG WITH SCREENS



Loop Leg · Brilliant White Scalloped Top



Loop Leg · Beech Top with Cable Entry Holes



Loop Leg · Warm White Top with Cable Entry Holes
Top Sizes in Brilliant White, Beech or Warm White:
1200W x 700D · 1500W x 700D · 1800W x 700D

CORNER WORKSTATION · LOOP LEG WITH SCREENS



Loop Leg · Warm White Corner Top with Cable Entry Holes



Loop Leg · Beech Corner Tops with Cable Entry Holes



Loop Leg · Top Sizes in Beech or Warm White:
1500W x 1800W x 700D · 1500W x 1500W x 700D
1800W x 1800W x 700D

NEW

NEW

NEW

RAPID INFINITY ACCESSORIES

RAPID INFINITY CENTRE SCREEN

IS1200, IS1500 or IS1800 B · Rapid Infinity Centre Screen
 Black Pinnable Fabric with White Frame
 1200mm W, 1500mm W or 1800mm W x 30mm D x 500mm H

CENTRE SCREEN



RAPID INFINITY RETURN DIVIDERS

IS700 B · Rapid Infinity 700mm Wide Return Dividers · 690mm W x 350 mm H x 20 mm Thick

INFINITY DIVIDERS



NEW

ETERNITY SLIMLINE PEDESTAL

EMP3 WB Eternity Slimline Mobile Pedestal
 300mm W x 535mm D x 580mm H

· Anti-Tilt Mechanism · Fifth Wheel for Added Stability · Master Key Locking Series · Two-Tone White Powdercoated Drawer Fronts and Top with Black Powdercoated Carcass · 2 Personal Drawers and 1 Filing Drawer · 100kg Overall Weight Rating · Suits Well with Rapid Infinity & Rapid Paramount Desking Systems · 10 Year Warranty

TWO-TONE SLIMLINE PEDESTAL



NEW



CABLE MANAGEMENT SOLUTIONS



Single Tier Cable Baskets Kits

- Under desk, for power only.



Dual Tier Cable Baskets Kits

- Under desk, for power and data.



Power Rails

- Above desk power and data, clamps onto desk top.



Power Pole Kits

- Run power from ceiling to workstation.



Flip Box

- Above desk power and data, sits flush in desk top.



In Desk Module - Use for Hot Desks

- Above desk power, data and USB, fits in 80mm cable port.



Boardroom Table Boxes

- Sits in table top, lid closes to obscure power and data points when not in use.



Pop Up Power - Use for Hot Desks

- Above desk power, data and USB.
Sits flush in desk top and pops up when in use.

Rapid Screen



RAPID SCREEN

Off the shelf, slimline workstation system with multiple configuration options. Slimline screen system with blue or grey screens in 1250mm or 1650mm heights

Choose between blue or grey pinnable fabric screens with warm white or beech desk tops.

Select from a range of different leg styles and colours to match your office design.

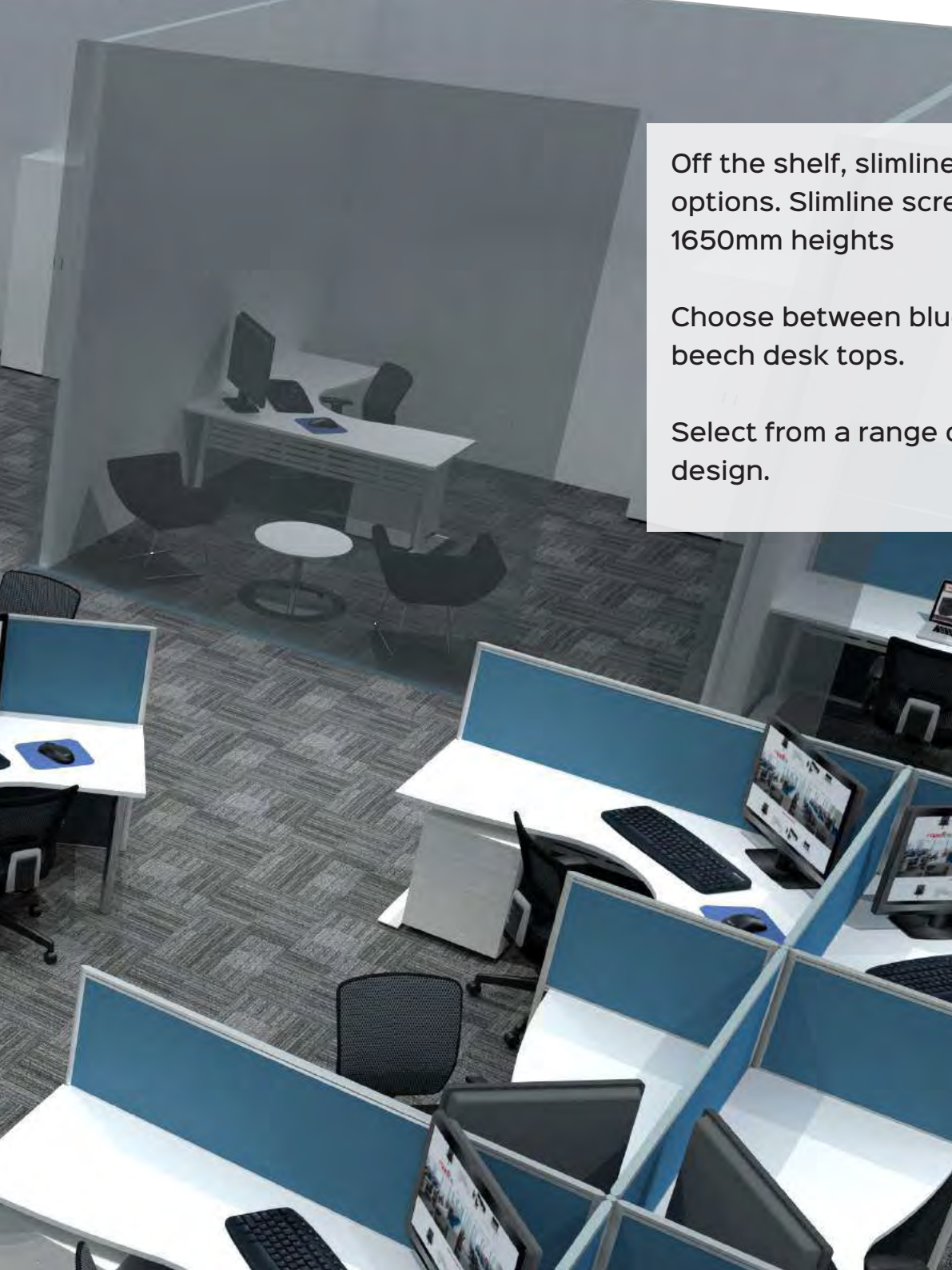

RAPID SCREEN

RAPID SCREEN STRAIGHT PODS



RAPID SCREEN CORNER PODS

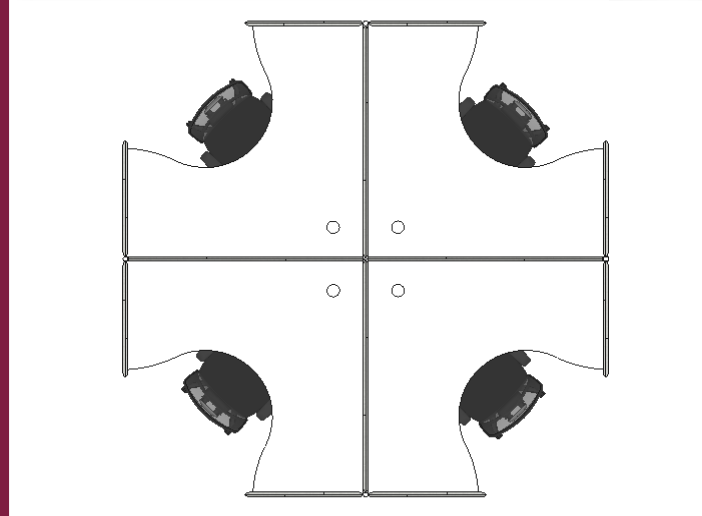
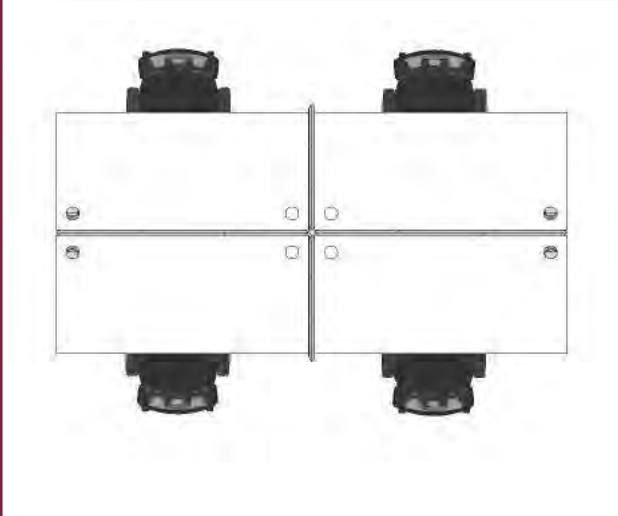

RAPID SCREEN 120 DEGREE PODS

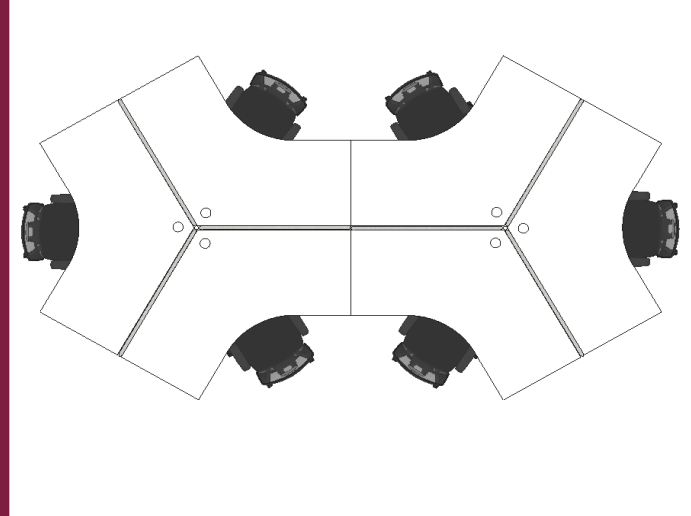

Components · **Tops:** T127 W, T157 W or T187 W
 1200W x 700D · 1500W x 700D · 1800W x 700D
Screens: SC1212, SC1512, SC1812 BU or GR
 1200W · 1500W · 1800W · 1250H or 1650H
Joining Pole: SC12/90 · 90 Degree Pole
Legs: SPLEG PS · Precious Silver Spleg Legs

Components · **Tops:** T1515 W, T1812 W, T1815W or T1818 W
 1500 x 1500 · 1800 x 1200 · 1800 x 1500 · 1800 x 1800
Screens: SC1212, SC1512, SC1812 BU or GR
 1200W · 1500W · 1800W · 1250H or 1650H
Joining Pole: SC12/90 · 90 Degree Pole
Legs: DC60-WC · DC-60 Legs in White China

Components · **Tops:** T1212-12-7 W · 120 Degree Top
 1200W x 1200W x 700D
Screens: SC1212, SC1216 BU or GR
 1200W · 1250H or 1650H
Joining Pole: SC12/120 · 120 Degree Pole
Legs: DC60-WC · DC-60 Legs in White China

WORKSTATION TOP COLOURS

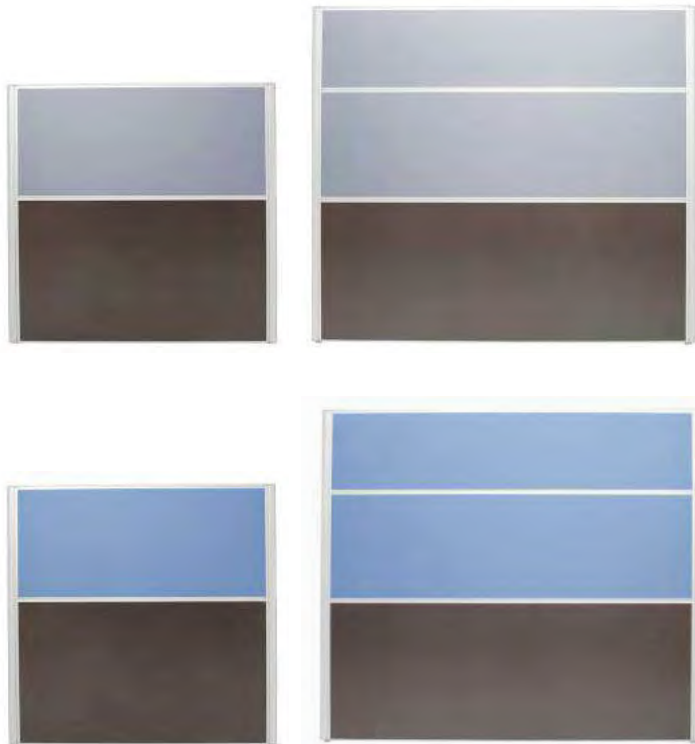

1250mm HIGH SCREEN 1650mm HIGH SCREEN

750mm, 1200mm, 1500mm or 1800mm W
x 1250mm or 1650mm H x 30mm T

SCREEN COLOURS



SCREEN ACCESSORIES



900mm Shelf
Shown with Brackets



4 Space Document Divider



Double Pen Holder



Triple Pen Holder



Document Tray



File Holder



Free Standing Foot with
Detachable Castors



Wall Starter

JOINING POLES



JOINING POLES

1250mm or 1650mm High
Link screens at 90, 180 or
120 degrees. Use in corners or to
join return screens.

Rapid Screen system allows ultimate flexibility to suit your space. Different top shapes and sizes, screen heights, leg options and storage choices allow for personalised workstation design.







RAPID SCREEN

Choose from a range of different leg options on your Rapid Screen workstation.

RAPID SCREEN LEG SYSTEMS



SPAN LEGS

705mm H x 560mm D
Adjustable feet and cable management in leg

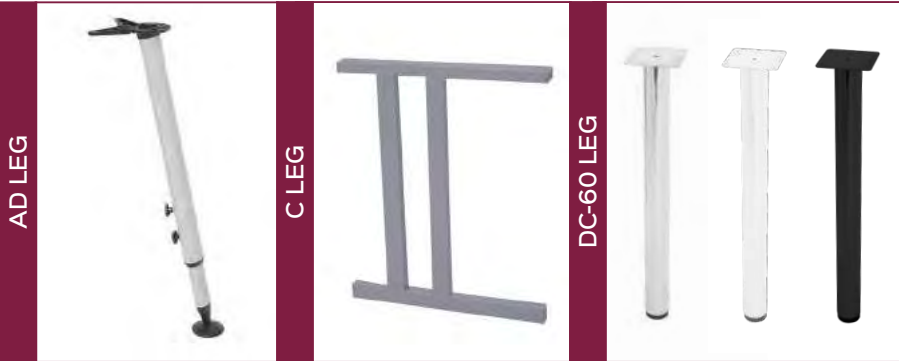

ADJUSTABLE LEG

650 - 800mm H
Adjustable Foot
· Silver or White

C LEG

705mm H x 550mm D
Adjustable Feet
· Silver

DC-60 POLE LEGS

60mm DIA. x 705mm H Round
Leg with Adjustable Foot
· Silver, White or Black



RAPID SPAN WHITE



RAPID SPAN WHITE

Create a contemporary, clean look with a choice of two top colours, three metal leg colours and a perforated metal modesty panel.

Add desk screens for extra privacy.



RAPID SPAN WHITE

DESK



Rapid Span Desk · Warm White Top & White Frame



Rapid Span Desk · Warm White Top & Silver Frame



Rapid Span Desk · Warm White Top & Black Frame
1200W x 700D · 1500W x 700D · 1800W x 700D

DESK & RETURN



Rapid Span Desk & Return · Warm White Top & White Frame



Rapid Span Desk & Return · Warm White Top & Silver Frame



Rapid Span Desk & Return · Warm White Top & Black Frame
1800W x 700D · 1100W x 600D Return

CORNER WORKSTATION



Rapid Span Corner Workstation · Warm White Top & White Frame



Rapid Span Corner Workstation · Warm White Top & Silver Frame



Rapid Span Corner Workstation · Warm White Top & Black Frame
1800W x 1200W x 700D x 750H · 1800W x 1800W x 700D x 730H
1800W x 1500W x 700D x 750H · 1500W x 1500W x 700D x 730H

ECO PANEL SCREEN



NEW

ECO PANEL SCREEN · Desk Mounted Screens (includes Screw Plates)
Pinnable Surface · Polyester Fibre · 27mm Thick x 284mm Total Height
EPS089 BK 890mm W · **EPS119 BK** 1190mm W · **EPS149 BK** 1490mm W

SLIDE ON SCREEN



NEW

ECO PANEL SLIDE ON SCREEN · Slide On
Divider Screen Pinnable Surface - Polyester Fibre
EPS60 BK · 600mm W x 300mm H x 27mm T

Create a modern office space with the Rapid Span White workstation range and matching furniture options.

CUPBOARD



SP2FD18 W · 900W x 450D x 1800H
Full Height Lockable Cupboard with 4
Shelves (3 Adjustable, 1 Fixed Shelf)

BOOKCASE



SPBC12 W · 900W x 315D x 1200H
SPBC18 W · 900W x 315D x 1800H
Bookcase with Adjustable Shelves

HUTCH



SPH12 W · 1200W x 315D x 1070H
SPH18 W · 1800W x 315D x 1070H
Hutch with Adjustable Shelves
*Additional Support Could Be Required Depending on Application



Warm White



CREDENZA



SPC12 W · 1200W x 450D x 730H
SPC18 W · 1800W x 450D x 730H
Lockable Credenza with Adjustable Shelves

MOBILE PEDESTAL



SPMP3 W · 447W x
465D x 690H
Lockable Mobile Pedestal

RAPID SPAN BEECH



RAPID SPAN BEECH

Create a warm, natural office space with a choice of two top colours, three metal leg colours and a perforated metal modesty panel. Add desk screens for extra privacy.

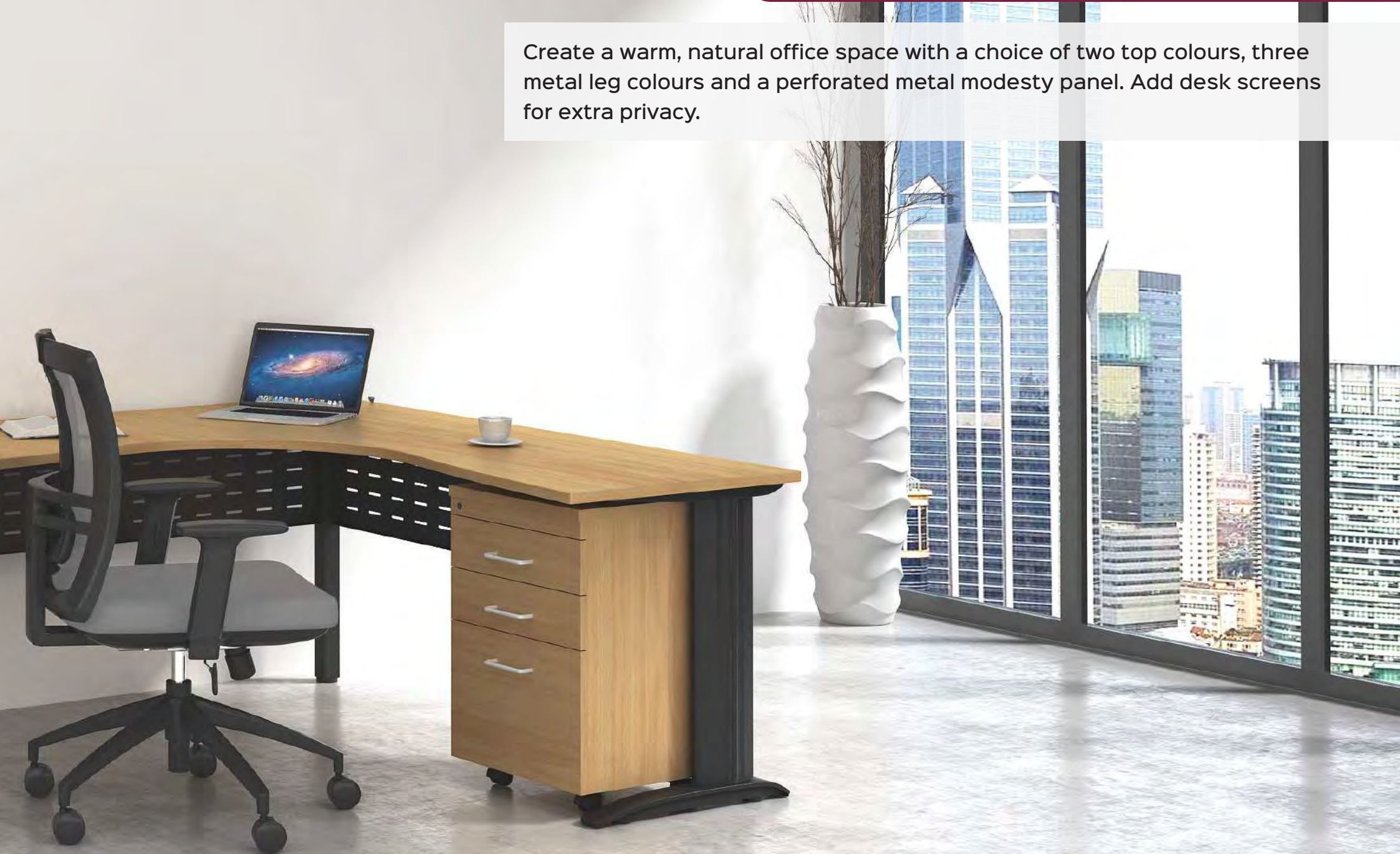

RAPID SPAN BEECH

DESK



Rapid Span Desk · Beech Top & White Frame



Rapid Span Desk · Beech Top & Silver Frame



Rapid Span Desk · Beech Top & Black Frame
1200W x 700D · 1500W x 700D · 1800W x 700D

DESK & RETURN



Rapid Span Desk & Return · Beech Top & White Frame



Rapid Span Desk & Return · Beech Top & Silver Frame



Rapid Span Desk & Return · Beech Top & Black Frame
1800W x 700D · 1100W x 600D Return

CORNER WORKSTATION



Rapid Span Corner Workstation · Beech Top & White Frame



Rapid Span Corner Workstation · Beech Top & Silver Frame



Rapid Span Corner Workstation · Beech Top & Black Frame
1800W x 1200W x 700D x 730H · 1800W x 1800W x 700D x 730H
1800W x 1500W x 700D x 730H · 1500W x 1500W x 700D x 730H

ECO PANEL SCREEN



NEW

ECO PANEL SCREEN · Desk Mounted Screens (includes Screw Plates)
Pinnable Surface · Polyester Fibre · 27mm Thick x 284mm Total Height
EPS089 BK 890mm W · EPS119 BK 1190mm W · EPS149 BK 1490mm W

SLIDE ON SCREEN



NEW

ECO PANEL SLIDE ON SCREEN · Slide On
Divider Screen Pinnable Surface - Polyester Fibre
EPS60 BK · 600mm W x 300mm H x 27mm T

Create the natural feel of timber with the Rapid Span Beech workstation range and matching furniture options.

CUPBOARD



SP2FD18 B · 900W x 450D x 1800H
Full Height Lockable Cupboard with 4 Shelves (3 Adjustable, 1 Fixed Shelf)

BOOKCASE



SPBC12 B · 900W x 315D x 1200H
SPBC18 B · 900W x 315D x 1800H
Bookcase with Adjustable Shelves

HUTCH



SPH12 B · 1200W x 315D x 1070H
SPH18 B · 1800W x 315D x 1070H
Hutch with Adjustable Shelves
*Additional Support Could Be Required Depending on Application



Beech



CREDENZA



SPC12 B · 1200W x 450D x 730H
SPC18 B · 1800W x 450D x 730H
Lockable Credenza with Adjustable Shelves

MOBILE PEDESTAL



SPMP3 B · 447W x 465D x 690H
Lockable Mobile Pedestal

TABLES



A table range to meet all requirements including boardrooms, meetings, break out areas, kitchen, training and education.



TABLES

ROUND BASE TABLE

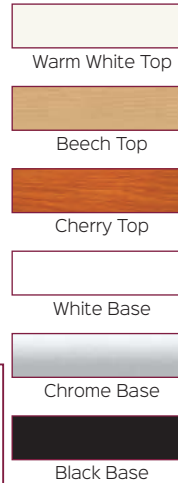

Round Base Table · Round Meeting Table in 3 Top Sizes, Available in Chrome, Black or White Powdercoated Round Table Base
CBT6 · 600mm DIA. x 730mm H · **CBT9** · 900mm DIA. x 730mm H
CBT12 · 1200mm DIA. x 730mm H



NEW



RAPID AIR ROUND TABLE

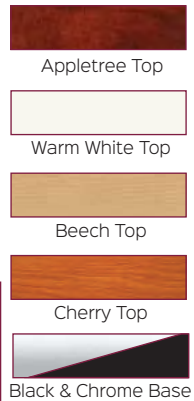

Rapid Air Round Table · Round Meeting Table with Rapid Air Tripod Chrome Base. Warm White, Cherry, Beech or Appletree Tops
RAR900 · 900mm DIA. x 750mm H
RAR1200 · 1200mm DIA. x 750mm H

4 STAR BASE ROUND TABLE

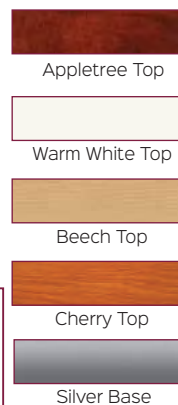

4 Star Base Round Table · Round Meeting Table with 4 Star Silver Base, Available with Warm White, Beech, Appletree or Cherry Tops
RSRT9 · 900mm DIA. x 730mm H
RSRT12 · 1200mm DIA. x 730mm H

TYPHOON ROUND TABLE

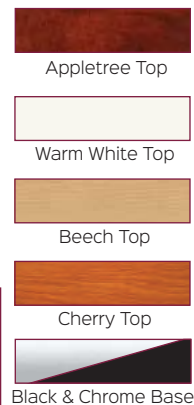

Typhoon Round Table · Round Meeting Table with Typhoon 4 Star Black and Chrome Base. Warm White, Cherry, Beech or Appletree Top
TTR900 · 900mm DIA. x 730mm H
TTR1200 · 1200mm DIA. x 730mm H

SILVER FRAME TABLE

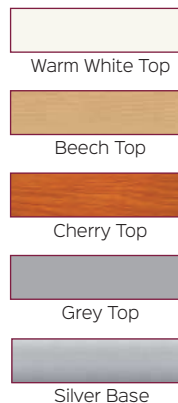

Steel Frame Table · Rectangular Shaped Top with Silver Angled Leg Frame, Adjustable Feet, Available in Two Sizes
RST1875 · 1800mm W x 750mm D · Warm White, Beech, Cherry or Grey
RST189 · 1800mm W x 900mm D · Warm White, Beech Cherry or Grey

FOLDING TABLE

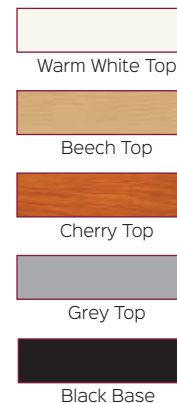

Folding Table · 30mm Black Steel Folding Frame Table, Legs with Adjustable Levelling Feet, Available in 3 Sizes with 730mm Height
FFT1575 · 1500mm W x 750mm D · **FFT1875** · 1800mm W x 750mm D
FFT189 · 1800mm W x 900mm D

FLIP TOP TABLE



Optional Extra:
Table Links

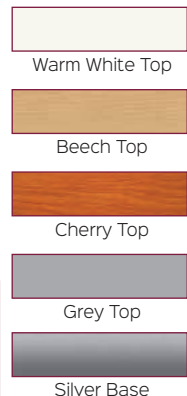

Flip Top Table · Precious Silver Flip Top Frame with Locking Castors, Use with Optional Extra Table Links to Connect Multiple Tables
FTT1575 · 1500mm W x 750mm D x 730mm H
FFT1875 · 1800mm W x 750mm D x 730mm H

TYPHOON FLIP TOP



Optional Extra:
Table Links

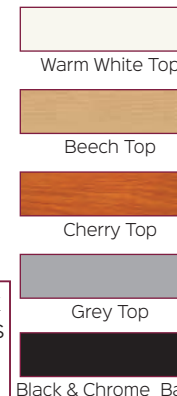



Typhoon Flip Top Table · Flip Top Table with Typhoon Frame in Black and Chrome, Locking Castors on Wheels, Available in 2 Different Sizes
TFT1575 · 1500mm W x 750mm D x 730mm H
TFT1875 · 1800mm W x 750mm D x 730mm H

TABLES

RAPID EDGE FOLDING TABLE







Rapid Edge Folding Table · 18mm Thick Top with Black Rubber Edging, Black and Polished Aluminium Frame with Locking Castors Includes Pair of Table Links
FBT2410 · 2400mm W x 1000mm D x 743mm H

-  Brilliant White Top
-  Driftwood Top
-  Black & Polished Aluminium Base

IRONSTONE BOARDROOM TABLE

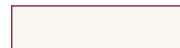

Ironstone Base Boardroom Table · Rectangular Shaped Top with Ironstone Melamine Base, 730mm Top Height
CBT2412 · 2400mm L x 1200mm D · White, Beech, Cherry or Appletree
CBT3212 · 3200mm L x 1200mm D · White, Beech or Cherry 2-Piece Top

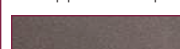
-  Warm White Top
-  Beech Top
-  Cherry Top
-  Appletree Top
-  Ironstone Base

TYPHOON BOARDROOM TABLE







Typhoon Boardroom Table · Boardroom Table with Typhoon Black Powdercoated Single Stage or Dual Stage Frame, 750mm Top Height
TTR189 · 1800mm L x 900mm W · White, Beech, Cherry or Grey Top
TTR2412 · 2400mm L x 1200mm W · White, Beech, Cherry or Appletree
TTR3212 · 3200mm L x 1200mm W · White, Beech or Cherry 2-Piece Top

-  Warm White Top
-  Beech Top
-  Cherry Top
-  Grey Top
-  Appletree Top
-  Black & Chrome Base

RAPID AIR BOARDROOM TABLE

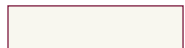

Rapid Air Boardroom Table · Suspended Top Boardroom Table with Rapid Air Polished Aluminium Single or Dual Stage Frame, 750mm Height
RAB2412 · 2400mm L x 1200mm D · White, Beech, Cherry or Appletree
RAB3212 · 3200mm L x 1200mm D · White, Beech or Cherry 2-Piece Top

-  Warm White Top
-  Beech Top
-  Cherry Top
-  Appletree Top
-  Polished Aluminium



STEEL FRAME TABLE

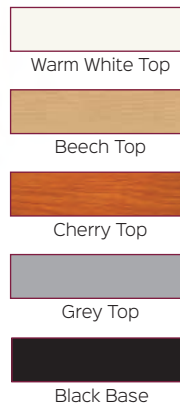

Steel Frame Table · 40mm Black Steel Frame and Legs with Adjustable Levelling Feet, Available in 4 Sizes with 730mm Height
SFT126 · 1200mm W x 600mm D · **SFT1575** · 1500mm W x 750mm D
SFT1875 · 1800mm W x 750mm D · **SFT189** · 1800mm W x 900mm D

HIGH BAR TABLE

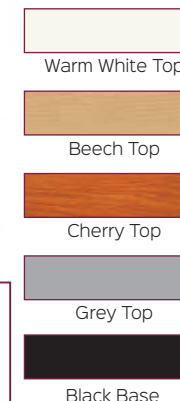

High Bar Table · Rectangular High Bar Table with Black Powdercoated Frame and Adjustable Levelling Feet
 1050mm Top Height
HBT189 · 1800mm W x 900mm D · **White, Beech, Cherry or Grey Top**

DRAFTING TABLE

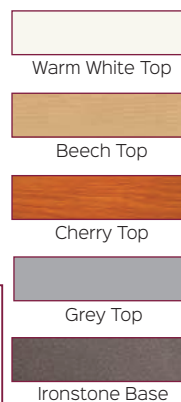

Drafting Height Steel Table · Rectangular Drafting Table with Black Powdercoated Steel Frame, 900mm Top Height
9SFT1575 · 1500mm L x 750mm D · **White, Beech, Cherry or Grey**
9SFT189 · 1800mm L x 900mm D · **White, Beech or Cherry or Grey**

DRY BAR ROUND TABLE

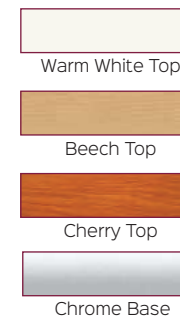

Dry Bar Round Table · Perfect for any Kitchen, Breakout or Hospitality Space, with Chrome Table Base, 1075mm Height
CDBT6 · 600mm DIA. · **White, Beech or Cherry Top**

High Tables
 Tables for drafting, hospitality or creating breakout areas.





HEIGHT ADJUSTABLE DESKS

Create a healthier work environment with height adjustable workstations, allowing users to alternate between sitting and standing whilst working, potentially eliminating multiple health risks.



RAPID SPAN ELECTRIC

For many people a standard 730mm high desk height will not allow them to work comfortably and efficiently. In a shared workstation environment, a height adjustable workstation is a valuable work tool to suit a range of different users.



STRAIGHT DESK



PRODUCT CODES

- SE 127 1200 W x 700 D
- SE 157 1500 W x 700 D
- SE 187 1800 W x 700 D
- SE 15157 1500 x 1500 x 700 D
- SE 18127 1800 x 1200 x 700 D
- SE 18157 1800 x 1500 x 700 D
- SE 18187 1800 x 1800 x 700 D

- Desk height 685 - 1205mm
- Maximum load 100kg
- Modesty panel for rigidity
- Stiffening rail for tops
- 31mm per second speed

CORNER WORKSTATION



COMPONENTS



SS-SPLEG
Frame in White or Precious Silver
Modesty Panel Optional Extra



SS-SPCNR
Corner Pole



SS-PSC · Optional Pre Set
Controller, 3 Height settings
for up to 3 users.





Warm White Top



Beech Top



White Frame

RAPID PARAMOUNT

The Paramount system exceeds expectations with stability, rigidity, strength and style.

The system provides full height adjustment from 630mm H to 1252mm H, and includes full cable management provisions with an adaptable built in cable tray which also allows the option for power and data as an added extra.

SINGLE HEIGHT ADJUSTABLE



Single Height Adjustable Workstation
Desk Height from 630-1252 mm
White Frame and Top, Maximum Load 100 kg
REP1P187
1800 W x 750 D

SINGLE WITH SCREEN HEIGHT ADJUSTABLE



Single Height Adjustable Workstation with Screen
Desk Height from 630-1252 mm, Black Screen 1695mm W x 805mm H
White Frame and Top, Maximum Load 100 kg
REPWS1P187
1800 W x 750 D

BACK TO BACK HEIGHT ADJUSTABLE



Back to Back Height Adjustable Workstation
Desk Height from 630-1252 mm, Black Screen 1695mm W x 805mm H
White Frame and Top, Maximum Load 100 kg
REPWS2P187
1800 W x 750 D Per User



NEW

RAPID FLUX SMALL



White



Black

RAPID FLUX SMALL

RF1 W · White · 880mm W x 415mm D x 120-500mm H
RF1 B · Black · 880mm W x 415mm D x 120-500mm H

Rapid Flux Electric Height Adjustable Desk Riser

- Height adjustable solution for your new or existing desk
- Available in two sizes and colours, 25kg weight capacity
- Height adjustable from 120mm - 500mm H
- Electric Riser speed 22mm per second
- Quiet height adjustment < 50DB motor noise
- Quick release keyboard tray
- Quick installation, no tools required
- Concealed motor makes for a clean and compact design
- MDF table top and keyboard tray
- Silver powder-coated frame on white riser, black powder-coated frame on black riser
- Black or White control panel buttons to match unit colour
- Grommet hole in worktop for use with monitor arms
- Built-in cable management

NEW

RAPID FLUX MEDIUM



White



Black

RAPID FLUX MEDIUM

RF2 W · White · 950mm W x 415mm D x 120-500mm H
RF2 B · Black · 950mm W x 415mm D x 120-500mm H

NEW

RAPID REFRESH MAT

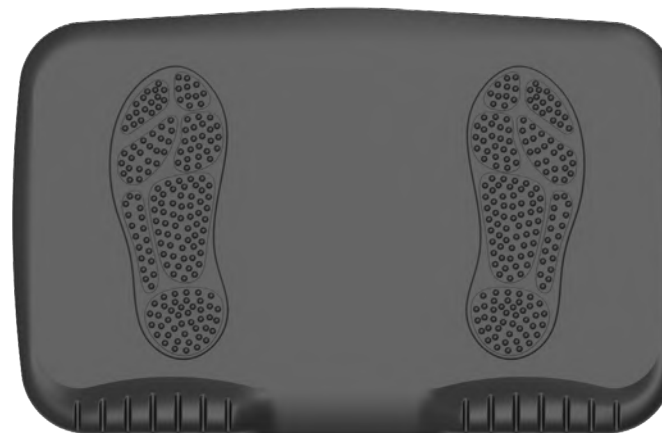

Black

RAPID REFRESH ANTI-FATIGUE MAT · Use with all Rapidline Height Adjustable Solutions when Standing.
RRM BL · 800mm W x 518mm D x 48mm Thickness

HEIGHT ADJUSTABLE DESKS

Rapid Surge Gas Lift Height Adjustable Desk

Standalone gas lift operated height adjustable desks, to adjust desk top height to suit user from sitting to standing position.

Improve posture, potentially reduce back pain and risk of weight gain by simply adjusting your work top height.

RAPID SURGE HEIGHT ADJUSTABLE



Rapid Surge · Gas Lift Operator Height Adjustable Desk
 Desk Height from 750mm to 1100mm, White Powdercoated Frame,
 Maximum Load 22kg, Control Levers Each Side,
 12 Different Height Settings
RS1 W · Worksurface Size 1190mm W x 590mm D · 750-1100mm H



White Top



White Frame

Manual Height Adjustable Desk

Standalone manual height adjustable workstation, adjust desk top height to suit user from sitting to standing position. Low geared mechanism for ease of adjustment. Universal crank handle, fold handle away when not in use.



TRIUMPH MANUAL HEIGHT ADJUSTABLE



Brilliant White Top

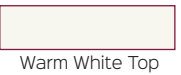

Warm White Top



Beech Top



White Frame

Manual Height Adjustable Desk · Manual Height Adjustable Desk
 with Fold Away Crank Handle, Desk Height from 715mm - 1015mm
 White Powdercoated Frame, Maximum Load 100kg
TMA127 · 1200mm W x 700mm D x 715-1015mm H
TMA157 · 1500mm W x 700mm D x 715-1015mm H
TMA187 · 1800mm W x 700mm D x 715-1015mm H

RAPID RISER

RAPID RISER SMALL



Rapid Riser Small

RR1 W · White · 680mm W x 590mm D x 150-500mm H
RR1 B · Black · 680mm W x 590mm D x 150-500mm H

White

Black

RAPID RISER MEDIUM



White

Black

Rapid Riser Medium

RR2 W · White · 890mm W x 590mm D x 150-500mm H
RR2 B · Black · 890mm W x 590mm D x 150-500mm H

Manual Height Adjustable Workstation

- Height adjustable solution for on top of existing desk or corner workstation.
- Height adjustment of 150mm - 500mm h
- Available in small or medium sizes
- Gas spring offers smooth and even height adjustment
- Large keyboard tray and wide work surface
- 15 Height adjustment levels
- Control levers on both sides
- Grommet hole for monitor arm mounting.
- Built in tablet or phone holder and cable tie for any leads or cables.



Attaches to your existing or new desk and allows movement of monitor to best suit users height and eyeline.

SINGLE MONITOR ARM



Single Monitor Arm
SMARM · White · 75-480mm Height Range, with 1 x USB 3.0 Port and 1 x Audio Port

REVOLVE SINGLE ARM



Revolve Single Monitor Arm
RMA1 BL · Black · Pole Mounted Single Monitor Arm, 200-360mm Height Range, Cable Management Within

REVOLVE QUAD ARM



Revolve Quad Monitor Arm
RMA4 BL · Black · Pole Mounted Quad Monitor Arm, 200-660mm Height Range, Cable Management Within

DUAL MONITOR ARM



Single Monitor Arm
DMARM · White · 75-480mm Height Range, with 2 x USB 3.0 Port and 1 x Audio Port

REVOLVE DUAL ARM



Revolve Dual Monitor Arm
RMA2 BL · Black · Pole Mounted Dual Monitor Arm, 200-400mm Height Range, Cable Management Within

ELEVATE ARM

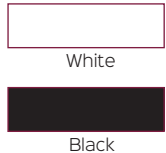

Elevate Single Monitor Arm
ELEVATE W · White · 180-480mm Height Range
ELEVATE B · Black · 180-480mm Height Range

RAPID VIBE



RAPID VIBE

All Warm White or Grey finishes for a clean, fresh look, 25mm thick tops on all desks and workstations. Locking storage and metal runners in all drawers.



LAPTOP DESK



Laptop Desk
CDK96 · 900mm W x 600mm D x 730mm H

HOME OFFICE DESK



Home Office Desk
CDK126 · 1200mm W x 600mm D x 730mm H
HDKP1D · Single Drawer Optional Extra

DESK RETURN



Desk Return
CR6 · 900mm W x 600mm D

DESK HOB



Desk Hob
CHOB18N · 1800mm W x 350mm D x 400mm H

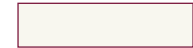

Warm White



Grey



OPEN DESK



Open Desk · Melamine Open Desk
CDK1575 · 1500mm W x 750mm D x 730mm H
CDK189 · 1800mm W x 900mm D x 730mm H

CORNER WORKSTATION



Corner Workstation · Melamine Corner Workstation
CWS1818 · 1800mm x 1800mm W x 600mm D x 730mm H

ECO PANEL SCREEN



NEW

ECO PANEL SCREEN · Desk Mounted Screens (includes Screw Plates)
Pinnable Surface · Polyester Fibre · 27mm Thick x 284mm Total Height
EPS089 BK 890mm W · EPS119 BK 1190mm W · EPS149 BK 1490mm W

SLIDE ON SCREEN



NEW

ECO PANEL SLIDE ON SCREEN · Slide On Divider Screen Pinnable Surface - Polyester Fibre
EPS60 BK · 600mm W x 300mm H x 27mm T



Warm White



Grey



CUPBOARD



SP2FD18 · 900mm W x 450mm D x 1800mm H
Full Height Lockable Cupboard with 4 Shelves (3 Adjustable, 1 Fixed Shelf)

BOOKCASE



SPBC12 · 900mm W x 315mm D x 1200mm H
SPBC18 · 900mm W x 315mm D x 1800mm H
Bookcase with Adjustable Shelves

HUTCH



SPH12 · 1200mm W x 315mm D x 1070mm H
SPH18 · 1800mm W x 315mm D x 1070mm H
Hutch with Adjustable Shelves

CREDENZA



SPC12 · 1200mm W x 450mm D x 730mm H
SPC18 · 1800mm W x 450mm D x 730mm H
Lockable Credenza with Adjustable Shelves

FIXED PEDESTAL



CDKP3D · 3 Drawers
Lockable Fixed Pedestal
Optional Extra for Desks

MOBILE PEDESTAL



SPMP3 · 447mm W x 465mm D x 690mm H
Lockable Mobile Pedestal

RAPID WORKER



RAPID WORKER

Sturdy, traditional, all melamine construction, 25mm thick tops on all desks and workstations. Locking storage and metal runners in all drawers.



RAPID WORKER



Beech / Ironstone



Cherry / Ironstone



OPEN DESK



- CDK96 · 900W x 600D x 730H
- CDK126 · 1200W x 600D x 730H
- CDK1575 · 1500W x 750D x 730H
- CDK1875 · 1800W x 750D x 730H
- CDK189 · 1800W x 900D x 730H

CORNER WORKSTATION



- Corner Workstation** · Melamine Corner Workstation with Cable Entry Hole
- 1200W x 1200W x 600D x 730H · 1200W x 1500W x 600D x 730H
 - 1200W x 1800W x 600D x 730H · 1200W x 2100W x 600D x 730H
 - 1500W x 1500W x 600D x 730H · 1800W x 1500W x 600D x 720H
 - 1800W x 1800W x 600D x 730H · 1800W x 1800W x 750D x 730H
 - 2100W x 1500W x 600D x 730H · 2100W x 1800W x 600D x 730H
 - 2100W x 2100W x 600D x 730H

FIXED PEDESTAL



- CDKP1D1F · 2 Drawers
- CDKP3D · 3 Drawers
- CRP3D · Return

DESK RETURN



- CR45 · 900mm W x 450mm D
- CR6 · 900mm W x 600mm D
- CR12 · 1200mm W x 600mm D

HUTCH



- CH12 · 1200mm W x 315mm D · 4 Shelves
 - CH15 · 1500mm W x 315mm D · 4 Shelves
 - CH18 · 1800mm W x 315mm D · 6 Shelves
- Hutch with Adjustable Shelves, 1070mm Height

CREDENZA



- CMZ1245 · 1200mm W x 450mm D x 730mm H
 - CMZ1545 · 1500mm W x 450mm D x 730mm H
 - CMZ1845 · 1800mm W x 450mm D x 730mm H
- Lockable Credenza with Adjustable Shelves

PIGEON HOLE UNIT



- 20 Hole Pigeon Unit**
- PH20 · 1040mm W x 380mm D
- 16 Shelves, 1040mm Height

FILING CABINET



- Lockable Filing Cabinet**
- 3 or 4 Drawers
 - C3FC · 465W x 600D x 990H
 - C4FC · 465W x 600D x 1300H

Huge range of shapes and sizes makes an office overhaul easy work.



Beech / Ironstone



Cherry / Ironstone



DESK RETURN



HDKP1D · 1 Drawer
Ironstone Singe Drawer
No Lock

DESK HOB



Desk Hob
CHOB15N · 1500mm W x 350mm D x 400mm H
CHOB18N · 1800mm W x 350mm D x 400mm H

CUPBOARD



CSC2FD · 900mm W x 450mm D x 1800mm H
Full Height Lockable Cupboard with 4 Shelves (3 Adjustable, 1 Fixed Shelf)

BOOKCASE



CBC9 · 900mm W x 315mm D x 900mm H
CBC12 · 900mm W x 315mm D x 1200mm H
CBC18 · 900mm W x 315mm D x 1800mm H
Bookcase with Adjustable Shelves

LOCKABLE WALL UNIT



CSC2HD · 900mm W x 450mm D x 1800mm H
Lockable Wall Unit with 2 Shelves and Lockable Storage Cupboard

MOBILE PEDESTAL



447W x 465D x 690H
CMP2F · 2 Drawers
CMP2D1F · 2 Drawers, 1 File
CMP4D · 4 Drawers

MOBILE PEDESTAL



447 W x 465D x 690H
CMP2D1F-I · 2 Drawers, 1 File
Ironstone · Lockable

RAPID MANAGER



RAPID MANAGER

Classic dark wood style, 25mm all over melamine or metal base desk options. Rounded corners on tops and full height modesty panel on melamine desks.



RAPID MANAGER



Appletree / Ironstone



OPEN DESK



*Drawers Not Included

Open Desk · Appletree and Ironstone with Cable Entry Holes
 Optional Extras: VR6 Return 900W x 600D and Lockable Drawers
VDK1575 · 1500W x 750D x 730H
VDK1875 · 1800W x 750D x 730H

METAL BASE DESK



Open Desk · Appletree Top, Black Base with Cable Entry Holes
VDKMB1575 · 1500W x 750D x 730H
VDKMB1875 · 1800W x 750D x 730H

MOBILE PEDESTAL



VMP2D1F · 2 Drawer, 1 File
 447W x 465D x 690H
 Lockable Mobile Pedestal

FIXED PEDESTAL



VDKP1D1F · 1 Drawer, 1 File
VDKP3D · 3 Drawers
 Use with Ironstone Base Only

OPEN CORNER WORKSTATION



Corner Workstation · Appletree One Piece Top 600mm Deep with Cable Entry Hole, Melamine Base
VCW186 · 1800W x 1800W x 600D x 730H

METAL BASE CORNER WORKSTATION



Corner Workstation · Appletree One Piece 700mm Deep Top, Black Metal Base, Modesty Panel and Cable Entry Hole
VCWMB186 · 1800mm W x 1800mm W x 700mm D x 730mm H

FILING CABINET



V4FC · 465W x 600D x 1300H
 Lockable Filing Cabinet
 4 Drawers of Storage Space

DESK HOB



VHOB18 · Reception Hob · 1800W x 300D x 400H
Add to Desk or Corner Workstation to Create a Reception Counter

Classic dark wood style, melamine or metal base desk options.
All Rapid Manger desk tops with rounded corners and full height modesty panel.

CUPBOARD



VSC2FD · 900mm W x 450mm D x 1800mm H
Full Height Lockable Cupboard with 4 Shelves
(3 Adjustable, 1 Fixed Shelf)

BOOKCASE



VBC18 · 900mm W x 315mm D x 1800mm H
Appletree with Ironstone Sides
Includes 4 Adjustable Shelves

HUTCH



VH18 · 1800mm W x 380mm D x 1050mm H
Appletree and Ironstone Hutch Storage
Use with Melamine Base Desks or Credenza



Appletree / Ironstone

CREDENZA



VCZ1245 · 1200mm W x 450mm D x 730mm H
VCZ1845 · 1800mm W x 450mm D x 730mm H
Lockable Credenza

TYPHOON ROUND TABLE



Typhoon 4 Star Base Table
TTR900 A · 900mm DIA. Top
TTR1200 A · 1200mm DIA. Top

CHAIRS



CHAIRS

A wide range of chairs for all applications, from heavy workload to home office use.

Seating for workstations, meeting areas, visitors, conferences and break out areas.



MESH CHAIRS

Chair Dimension Codes

- SW · Seat Width
- SD · Seat Depth
- BH · Back Height
- SH · Seat Height
- GH · Gas Height Range

MOTION



NEW



MMC BG · Mesh Back Task Chair with Grey Seat, Donati-Dopo Weight Sensitive Mechanism, Seat Slide, Lumbar Cushion and 3D Adjustable Arms. SW 490mm · SD 460mm · GH 440-530mm

GESTURE



NEW



GTC BK · Mesh Back Task Chair with Grey Seat, Synchro-Dynamic Mechanism, Seat Slide and Synchronised Back Rest and Seat Pan Tilt. SW 480mm · SD 470mm · GH 450-540mm

LUMINOUS



LUMINOUS · High Back Black Mesh Executive Chair with Synchro Mechanism, Adjustable Arms and Stylish White and Grey Frame. SW 480mm · SD 545mm · GH 420-510mm

Chair Dimension Codes

SW · Seat Width

SD · Seat Depth

BH · Back Height

SH · Seat Height

GH · Gas Height Range



ERGO



ERGO · Fully Ergonomic Black Mesh Back Chair with Seat Slide and Ratchet Back, Suitable for Heavy Duty Use. Weight rating of 165kgs.
SW 520mm · SD 490mm · GH 450-540mm

HARTLEY TASK



HARTLEY TASK · Synchro Mechanism with Tension Control, Black Mesh Back and Seat, with Adjustable Arms
SW 500mm · SD 480mm · GH 440-520mm

HARTLEY VISITOR



HARTLEY VISITOR · Black Cantilever Frame, Adjustable Arms and Black Mesh Back Visitor Chair with Comfortable Padded Fabric Seat
SW 510mm · SD 480mm · GH 485mm

MESH CHAIRS

Chair Dimension Codes

- SW · Seat Width
- SD · Seat Depth
- BH · Back Height
- SH · Seat Height
- GH · Gas Height Range

KAL



KAL · Black High Mesh Back with Lumbar Support, Synchro Mechanism and Adjustable Arms. Weight rating of 135kgs.
SW 500mm · SD 510mm · GH 430-520mm

ZOOM



ZOOM TABLET for use with Zoom Chair ONLY.



ZOOM · Mesh Back, Foldable Training and Conference Chair with Optional Extra Foldable Tablet Arm
SW 460mm · SD 490mm · SH 330mm

DAM



DAM · AFRDI Level 6, Fully Ergonomic with Tension Control, Heavy Duty Black Mesh Back, Ratchet Back and Adjustable Arms
SW 520mm · SD 470mm · GH 520-600mm

Chair Dimension Codes

- SW · Seat Width
- SD · Seat Depth
- BH · Back Height
- SH · Seat Height
- GH · Gas Height Range



AM100



AM100 · Fully Ergonomic with Curved Black Mesh Back, Black Fabric Seat and Adjustable Arms
SW 470mm · SD 490mm · GH 460-550mm



AM200



AM200 · Medium Black Mesh Back with Fabric Seat, Infinite Lock Tilt, Adjustable Arms, Polished Base
SW 520mm · SD 500mm · GH 420-520mm



RIVER



RIVER · Mesh Back with Comfortable Fabric Seat, Synchro Back and Seat Tilt Adjustment, Ratchet Back, Adjustable Arms as Optional Extra
SW 480mm · SD 470mm · GH 460-570mm

MESH CHAIRS

The Rapidline mesh chair range covers the full spectrum from heavy commercial use with full adjustment and high comfort, to Home and light work suitability.

Chair Dimension Codes

- SW · Seat Width
- SD · Seat Depth
- BH · Back Height
- SH · Seat Height
- GH · Gas Height Range

EM300



Black Fabric Seat
Black PU Seat



EM300 · Fully Ergonomic Mesh Back, Black Fabric or Black PU Seat, Optional Extra Chrome Base or Arms.
SW 490mm · SD 440mm · GH 460-590mm

VESTA



VESTA · Black Mesh Back Chair with Black Fabric Seat, Suitable for Home Office Use
SW 460mm · SD 460mm · GH 430-530mm

VIENNA

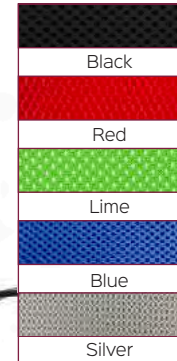

VIENNA · Mesh Back Chair with Arms, Suitable for Home Office or Light Commercial Use
SW 490mm · SD 490mm · GH 430-550mm

RE100



RE100 · Black Plastic Perforated Back, Single Point Lock with Arms, Suitable for Home Office Use
SW 510mm · SD 500mm · GH 470-590mm

MESH CHAIRS

Chair Dimension Codes

- SW · Seat Width
- SD · Seat Depth
- BH · Back Height
- SH · Seat Height
- GH · Gas Height Range

Our mesh range is not only designed for workstation areas.

Also use for visitor, meeting, boardroom and conference spaces.

WM600



WM600 · Ideal Meeting Chair with Chrome Base and Arms, Comfortable Black Mesh Material
SW 510mm · SD 420mm · GH 480-590mm

WMCC



WMCC · Black Mesh Back Visitor Chair with Fabric Seat, Cantilever Chrome Frame and Arms
SW 470mm · SD 470mm · BH 500mm

WMVBK



WMVBK · Black Mesh Back Visitor Chair or Meeting Chair with Arms and Chrome Legs
SW 480mm · SD 480mm · SH 480mm

PMVBK



PMVBK · Black Mesh Back, Plastic Seat with Sled Base, Linking and Stacking Chair
SW 455mm · SD 460mm · SH 300mm

OPERATOR CHAIRS

OPTIONAL EXTRAS



ADJUSTABLE ARMS

DRAFTING KIT

CHROME BASE

High quality range of fabric operator chairs to suit a range of users.

Chair Dimension Codes

- SW · Seat Width
- SD · Seat Depth
- BH · Back Height
- SH · Seat Height
- GH · Gas Height Range

NEW SF CHARCOAL FABRIC



ET20



ET20 · Black Fabric Medium Back Chair with Gas Lift, Back and Seat Tilt with Injection Moulded Foam
SW 480mm · SD 460mm · GH 420-530mm



EC070CH

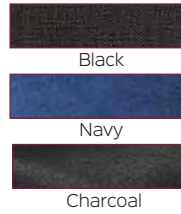

EC070CH · High Back with Seat and Back Tilt, Gas Lift, Injection Moulded Foam Seat and Back
SW 500mm · SD 450mm · GH 470-600mm



EC070BM

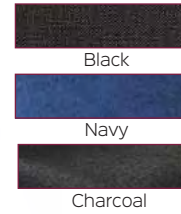

EC070BM · AFRDI Level 6, Medium Back Fabric Chair with Back Tilt and Gas Lift
SW 500mm · SD 450mm · GH 470-600mm



EC070BH



EC070BH · High Back Operator Chair with Back Tilt, Gas Lift and Injection Moulded Foam Seat
SW 500mm · SD 450mm · GH 470-600mm

OPTIONAL EXTRAS



ADJUSTABLE ARMS

DRAFTING KIT

CHROME BASE

NEW SF CHARCOAL FABRIC

Chair Dimension Codes

SW · Seat Width

SD · Seat Depth

BH · Back Height

SH · Seat Height

GH · Gas Height Range

EC070CM

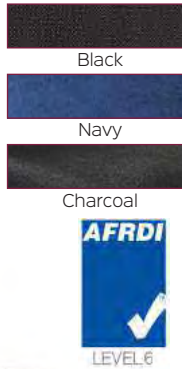

EC070CM · AFRDI Level 6, Fully Ergonomic Medium Back Fabric Chair, Seat and Back Tilt with Gas Lift
SW 500mm · SD 450mm · GH 470-600mm

F300



F300 · 3 Lever Black Fabric Upholstered Chair with Ratchet Back Adjustment, Seat Slide and Adjustable Arms
SW 540mm · SD 450mm · GH 510-590mm

EC070BM DRAFTING CHAIR



Adjustable Arms for Drafting Chair available as optional extra.



EC070BM DRAFTING CHAIR · Medium Back Drafting Chair with Back Tilt, Gas Lift and Injection Moulded Foam, Adjustable Arms Available as Optional Extra.
SW 500mm · SD 450mm · GH 630-800mm

OPERATOR CHAIRS

Choose from a range of standard fabric colours to suit your office.

Chair Dimension Codes

SW · Seat Width

SD · Seat Depth

BH · Back Height

SH · Seat Height

GH · Gas Height Range

NEW SF CHARCOAL FABRIC



ST50

ST50 · AFRDI Level 6, Fully Ergonomic, Ratchet Back, Black Fabric, Optional Extra Adjustable Arms
SW 500mm · SD 470mm · BH 460-600mm



EG100CH

EG100CH · AFRDI Level 6, Fully Ergonomic with Back and Seat Tilt, Gas Lift, High Back for User up to 130kg
SW 520mm · SD 480mm · GH 438-620mm



SWIFT

SWIFT BL · High Back Black Fabric Operator Chair, Seat and Back Tilt, Infinite Tilt Lock and Chrome Spider Base
SW 540mm · SD 450mm · GH 510-590mm



PU300

PU300 · Fully Ergonomic Soft Black PU Chair, Ratchet Back, Seat Slide, Chrome Base and Adjustable Arms
SW 540mm · SD 450mm · GH 510-590mm

Chair Dimension Codes

SW · Seat Width

SD · Seat Depth

BH · Back Height

SH · Seat Height

GH · Gas Height Range

Hard wearing chairs with a combination of comfort and style.

NEW SF CHARCOAL FABRIC

EG400

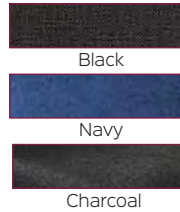

EG400 · AFRDI Level 6, Fully Ergonomic with Back and Seat Tilt, Square Back for User up to 130kg
SW 520mm · SD 480mm · BH 480-620mm

PO500

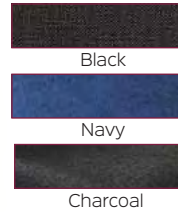

PO500 · AFRDI Level 6, Fully Ergonomic High Back Chair, Seat and Back Tilt with Gas Lift. 150kg Weight Rating. SW 530mm · SD 510mm · GH 490-590mm

DS DESK



DS DESK STOOL · 400mm Round Seat Desk Stool, Easy to Clean Black PU Material
SW 400mm · SD 400mm · GH 450-570mm

DS COUNTER STOOL



DS COUNTER STOOL · 400mm Round Seat Counter Stool with Drafting Kit, Easy to Clean Black PU Material
SW 400mm · SD 400mm · GH 650-870mm

VISITOR CHAIRS

Chair Dimension Codes

SW · Seat Width

SD · Seat Depth

BH · Back Height

SH · Seat Height

GH · Gas Height Range

Visitor chairs to suit all occasions.



HARTLEY VISITOR



HARTLEY VISITOR · Mesh Back Visitor Chair with Black Fabric Seat, Black Cantilever Frame with Adjustable Arms
SW 510mm · SD 480mm · BH 485mm



WMCC



WMCC · Black Mesh Back, Black Fabric Seat, Stylish Cantilever Frame with Arms
SW 470mm · SD 470mm · BH 500mm

WMVBK



WMVBK · Mesh Back, Black Fabric Seat Visitor or Meeting Chair, Chrome Legs, Arms
SW 480mm · SD 480mm · BH 480mm

COMFO



COMFO · Visitor or Meeting Chair, Chrome Cantilever Base with Curved Arm Rests
SW 510mm · SD 490mm · BH 510mm

CL2000V



CL2000V · Slimline Cantilever Visitor Chair, Outward Adjust on Arms, Chrome Base
SW 510mm · SD 500mm · BH 630mm

NOVA



NOVA · Fabric Seat and Back with Black Frame, Linking and Stackable
SW 448mm · SD 444mm · BH 338mm

VISITOR CHAIRS

FERNANDO



FERNANDO · Stylish Black PU Chrome Frame with Cut Out Back Feature, Stackable
SW 425mm · SD 420mm · BH 480mm

V100



V100 · Comfortable Black Fabric Visitor Chair with Black Frame, Stackable
SW 450mm · SD 450mm · BH 460mm

High quality range of Visitor chairs to suit a range of uses such as Desk, meeting or kitchen.

Chair Dimension Codes

- SW** · Seat Width
- SD** · Seat Depth
- BH** · Back Height
- SH** · Seat Height
- GH** · Gas Height Range

VSB600



VSB600 · Heavy Duty Visitor or Meeting Chair, Black Sled Base and Padded Arm Rests, in Black PU or Fabric
SW 490mm · SD 510mm · BH 380mm



P100



P100 · Polypropylene Plastic Stacking Chair in Black
SW 450mm · SD 370mm · BH 405mm

WV100 BL



WV100 BL · Comfortable Black Fabric Chair with Chrome Sled Base, Modern and Stylish Design
SW 440mm · SD 430mm · BH 450mm

EXECUTIVE CHAIRS

Chair Dimension Codes

SW · Seat Width

SD · Seat Depth

BH · Back Height

SH · Seat Height

GH · Gas Height Range

PELLE HIGH BACK

NEW



PHB BL · High Back Executive Chair in Black PU Leather, Seat and Back Tilt with Multi-Lock and Chrome 5 Star Spider Base
SW 500mm · SD 560mm · GH 425-540mm

PELLE MEDEIUM BACK

NEW



PMB BL · Medium Back Executive Chair in Black PU Leather, Seat and Back Tilt with Multi-Lock, Chrome 5 Star Spider Base
SW 500mm · SD 560mm · GH 425-540mm

PELLE VISITOR

NEW



PVM BM · Medium Back Executive Visitor Chair in Black PU Leather, with Chrome Cantilever Base, Seat and Back Tilt with Multi-Lock
SW 500mm · SD 560mm · SH 425mm

Chair Dimension Codes

SW · Seat Width

SD · Seat Depth

BH · Back Height

SH · Seat Height

GH · Gas Height Range

Where style and comfort are required.



ENDURE 160



ENDURE 160 · High Back, Heavy Duty Black Fabric Task Chair, Italian Synchro Mechanism, for User up to 160kg
SW 530mm · SD 510mm · GH 460-560mm



LANDER



LANDER · Fully Ergonomic Heavy Duty Mechanism, Black Leather, Adjustable Arms, for User up to 150kg
SW 510mm · SD 510mm · GH 480-580mm



CL710



CL710 · Soft Black PU Upholstery, 4 Point Tilt Lock, High Back Executive Chair with Curved Armrests
SW 530mm · SD 530mm · GH 460-550mm



CL820



CL820 · Soft Black PU Upholstery, Infinite Tilt Lock, Curved Chrome Arms and Base
SW 520mm · SD 480mm · GH 420-490mm

EXECUTIVE CHAIRS

Choose between a modern or more traditional look.

Chair Dimension Codes

SW · Seat Width

SD · Seat Depth

BH · Back Height

SH · Seat Height

GH · Gas Height Range

CL410



CL410 · Soft Black PU Upholstery with Fabric Inlay, Infinite Tilt Lock, Curve Arm Rests and Chrome Base
SW 540mm · SD 500mm · GH 450-550mm

CL610



CL610 · Soft Black PU Upholstery, Single Point Tilt Lock, Medium Back with Curved Armrests
SW 494mm · SD 500mm · GH 450-580mm

PU900M



PU900M · Medium Back with Upholstered Black PU, Single Point Lock, Polished Aluminium Base and Arms
SW 520mm · SD 435mm · GH 460-545mm

CL2000V



CL2000V · Cantilever Leather Look Visitor Chair with Slimline Chrome Frame, Outward Adjust on Arms
SW 500mm · SD 500mm · BH 630mm

Chair Dimension Codes

SW · Seat Width

SD · Seat Depth

BH · Back Height

SH · Seat Height

GH · Gas Height Range

Suitable for desk and boardroom use.

CL2000M



CL2000M · Medium Back Leather Look Slimline Executive Chair, Multi Position Lock Tilt, Outward Adjust on Arms
SW 510mm · SD 500mm · GH 500-565mm

CL2000H



CL2000H · High Back Leather Look Slimline Executive Chair, Multi Position Lock Tilt, Outward Adjust on Arms
SW 510mm · SD 500mm · GH 500-565mm

PU605M



PU605M · Medium Back Black PU Executive Chair with Infinite Lock, Chrome Arms and Base
SW 485mm · SD 460mm · GH 490-610mm

PU605H



PU605H · High Back Black PU Executive Chair with Infinite Lock, Chrome Arms and Base
SW 485mm · SD 460mm · GH 490-610mm

CONFERENCE & EVENTS CHAIRS

Chair Dimension Codes

- SW · Seat Width
- SD · Seat Depth
- BH · Back Height
- SH · Seat Height
- GH · Gas Height Range



ZOOM TABLET for use with Zoom Chair ONLY.

ZOOM · Mesh Back with Back Rest Tilt, Foldable Training and Conference Chair, Optional Extra Foldable Tablet Arm
SW 460mm · SD 490mm · BH 330mm

WIMBLEDON CHAIR OPTIONS



With Arms



Tablet Arm



Seat & Back Pad



Custom Upholstery (Lead Time applies)



WIMBLEDON · Black Plastic Seat and Back, Chrome Sled Base, Linking and Stackable with Range of Optional Extra's
SW 425mm · SD 430mm · BH 245mm



Trolley available for PMVBK, ZOLA, ZING and WIMBLEDON Chairs ONLY.



ZOLA · Black Plastic Seat and Curved Back, Chrome Frame, Stackable
SW 445mm · SD 450mm · BH 310mm



Optional Extra: Arms for ZING chair



ZING · Large Black Plastic Back and Seat with Chrome Frame, Linking and Stackable
SW 465mm · SD 430mm · BH 370mm



PT Chair · Foldable Chair in Off-White, with Silver Powdercoated Frame
SW 440mm · SD 435mm · BH 290mm · BW 500mm

HOSPITALITY CHAIRS

ALOHA

NEW



ALOHA Chair
Optional Extras:
Fabric Seat Covers

ALOHA · White Elastic Polypropylene Breakout or Meeting Chair with Silver Legs. Seat Covers Extra.
SW 430mm · SD 430mm · BH 370mm



Black Seat - ASP BK

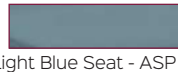

Light Blue Seat - ASP BU

VIRGO CHAIR

Virgo Chair: Available in Grey with Black Fabric Seat Pad or Black with Grey Fabric Seat Pad



VIRGO CHAIR · Timber Leg Breakout Chair
W 440mm · D 440mm · H 825mm
SH 470mm · SW 480mm



Grey Shell / Black Pad



Black Shell / Grey Pad

Perfect for informal, breakout, kitchen and eating areas.

Chair Dimension Codes

- SW · Seat Width
- SD · Seat Depth
- BH · Back Height
- SH · Seat Height
- GH · Gas Height Range

MAUI

NEW



MAUI · Polypropylene Chair with White and Slate Grey Frame. Grey Fabric Seat Cover Included.
SW 465mm · SD 450mm · BH 395mm

TAURUS



White

Black



TAURUS · Indoor Hospitality Chair with Chrome Base and Back Cut Out Feature, Black or White Plastic
SW 490mm · SD 510mm · BH 380mm

LEO



White

Black



LEO · Plastic Hospitality Chair Suitable for Indoor or Outdoor Use, Aluminium Legs, Black or White Plastic
SW 420mm · SD 410mm · BH 420mm

PIPEE



White

Green

Black



PIPEE · Polypropylene Plastic Stacking Chair, Holds up to 150kg, High Luster Shine
SW 425mm · SD 420mm · BH 480mm

HOSPITALITY STOOLS

Ideal for break out areas.

Chair Dimension Codes

- SW · Seat Width
- SD · Seat Depth
- BH · Back Height
- SH · Seat Height
- GH · Gas Height Range

TAURUS BAR STOOL

- White Seat
- Black Seat



TAURUS BAR STOOL · Indoor Hospitality Stool with Chrome Base, 750mm Seat Height, 1050mm Overall Height
 SW 435mm · SD 455mm · SH 750mm · BH 345mm

VIRGO STOOL

- Grey Seat
- Black Seat
- Green Seat



VIRGO STOOL · Stylish Timber Leg Stool
 Overall Dimensions · W - 475mm · D - 475mm · H - 820mm
 Seat Dimensions · SH - 770mm · SW - 440mm

ARIES STOOL

- Black Seat
- Grey Seat
- Green Seat



ARIES STOOL · Stylish Metal Leg Stool
 Overall Dimensions · W - 455mm · D - 545mm · H - 853mm
 Seat Dimensions · SH - 760mm · SW - 440mm

HOSPITALITY STOOLS



STORAGE & ACCESSORIES



STORAGE & ACCESSORIES



OTTOMANS

Chair Dimension Codes

SW · Seat Width

SD · Seat Depth

BH · Back Height

SH · Seat Height

GH · Gas Height Range

Soft Seating Ottomans provide communal, breakout and collaboration qualities to your office space. Choose from a variety of shapes, sizes & styles.

VENUS OTTOMAN



VENUS OTTOMAN · Use as an Ottoman or Foot Stool, Black PU Finish with Stainless Steel Frame, Matches Venus Lounge Range for Reception or Breakout Spaces
SW 1030mm · SD 540mm · SH 410mm



CONNECT 2 OTTOMAN



White

CONNECT 2 OTTOMAN · Black Fabric Seat, White Powdercoated Steel Base, for User up to 110kg
SW 320mm · SD 320mm · SH 420mm

MARS ROUND



Charcoal

MARS ROUND · Upholstered Round Ottoman in Charcoal Fabric
SW 550mm · SD 550mm · SH 450mm

MARS SQUARE



Charcoal

MARS SQUARE · Upholstered Square Ottoman in Charcoal Fabric
SW 550mm · SD 550mm · SH 450mm

MARS TRIANGLE



Charcoal

MARS TRIANGLE · Upholstered Triangle Ottoman in Charcoal Fabric
SW 550mm · SD 550mm · SH 450mm

SLIDE ON SCREEN



NEW



ECO PANEL SLIDE ON SCREEN · Slide On Divider Screen Pinnable Surface · Polyester Fiber
EPS60 BK · 600mm W x 300mm H x 27mm Thick

ECO PANEL SCREEN



NEW

ECO PANEL SCREEN · Desk Mounted Screens (includes Screw Plates) Pinnable Surface · Polyester Fiber · 27mm Thick x 284mm Total Height
EPS089 BK 890mm W · **EPS119 BK** 1190mm W · **EPS149 BK** 1490mm W

CORNER LOZENGE



CORNER LOZENGE · Converts Desk and Return to a Corner Workstation, To Fit 25mm or 33mm D Tops

LOZENGE25 250mm W x 480mm L x 25mm D
LOZENGE33 250mm W x 480mm L x 33mm D

RAPID REFRESH MAT



NEW



RAPID REFRESH MAT · Use with Height Adjustable Workstations when Standing.
RRM BL · 800mm W x 518mm D x 48mm Thickness

ACOUSTIC SCREENS

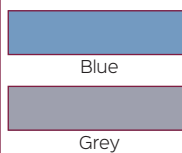

ACOUSTIC SCREENS · Free Standing Dividing Office Panels, 50mm Thick, Pinnable, Black PVC Edging and Silver Feet. Available in Blue or Grey Fabric

1515SCREEN · 1500mm W x 1500mm H x 50mm D **1518SCREEN** · 1500mm W x 1800mm H x 50mm D
1815SCREEN · 1800mm W x 1500mm H x 50mm D **1818SCREEN** · 1800mm W x 1800mm H x 50mm D

UTILITY TROLLEY



3 Tier Utility Trolley TR3 · Ironstone Only
800W x 600D x 900H

CHAIR MAT

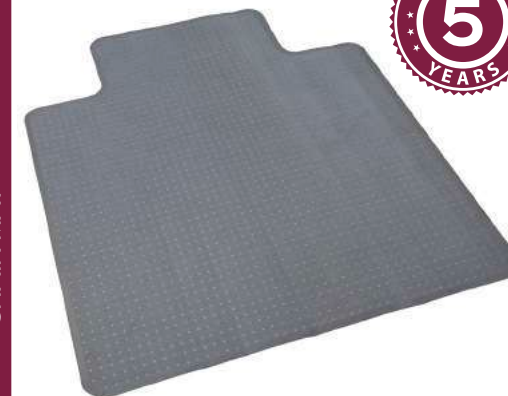

CHAIR MAT · Dimpled Chair Mat for Use on Carpets, Smooth Chair Mat for Use on Hard Floors
MAT S · Small Dimpled · 915mm W x 1200mm L x 20mm D
MAT L · Large Dimpled · 1140mm W x 1350mm L x 20mm D
MAT SM S · Small Smooth · 915mm W x 1200mm L x 20mm D
MAT SM L · Large Smooth · 1140mm W x 1350mm L x 20mm D

WHITEBOARDS & GLASSBOARDS

STANDARD WHITEBOARD



STANDARD WHITEBOARD · Wall Mounted Aluminium Framed Magnetic Whiteboard, Pen Tray, Concealed Corner Fixing, Acrylic Polyester Resin

W96 · 900W x 600H x 15D	W129 · 1200W x 900H x 15D
W1212 · 1200W x 1200H x 15D	W159 · 1500W x 900H x 15D
W1512 · 1500W x 1200H x 15D	W189 · 1800W x 900H x 15D
W1812 · 1800W x 1200H x 15D	W219 · 2100W x 900H x 15D
W2112 · 2100W x 1200H x 15D	W2412 · 2400W x 1200H x 15D

PORCELAIN WHITEBOARD



PORCELAIN WHITEBOARD · Wall Mounted Porcelain Whiteboard

PWB96 · 900W x 600H x 15D	PWB129 · 1200W x 900H x 15D
PWB1212 · 1200W x 1200H x 15D	PWB159 · 1500W x 900H x 15D
PWB1512 · 1500W x 1200H x 15D	PWB189 · 1800W x 900H x 15D
PWB1812 · 1800W x 1200H x 15D	PWB2112 · 2100W x 1200H x 15D
PWB2412 · 2400W x 1200H x 15D	PWB3012 · 3000W x 1200H x 15D
PWB3612 · 3600W x 1200H x 15D	

Wall mounted or mobile Whiteboards in standard or premium porcelain finish.

For a designer look, Glassboards have a stain free writing surface and can be used with a standard white board marker.



MOBILE WHITEBOARD



MOBILE WHITEBOARD · Double Sided Pivoting Mobile Whiteboard with Pen Tray

M129 · 1200W x 900H x 15D	M159 · 1500W x 900H x 15D
M1512 · 1500W x 1200H x 15D	M189 · 1800W x 900H x 15D
M1812 · 1800W x 1200H x 15D	

MOBILE PORCELAIN WHITEBOARD



MOBILE PORCELAIN WHITEBOARD · Double Sided Pivoting Mobile Porcelain Whiteboard with Pen Tray

PMW129 · 1200W x 900H x 15D	
PMW1512 · 1500W x 1200H x 15D	
PMW1812 · 1800W x 1200H x 15D	

GLASSBOARD

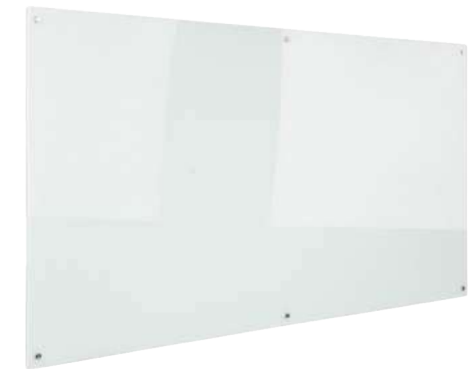

Glassboard · Glassboard Writing Board with Chrome Fittings

GB96 · 900W x 600H x 15D	GB129 · 1200W x 900H x 15D
GB159 · 1500W x 900H x 15D	GB1512 · 1500W x 1200H x 15D
GB189 · 1800W x 900H x 15D	GB1812 · 1800W x 1200H x 15D
GB2112 · 2100W x 1200H x 15D	GB2412 · 2400W x 1200H x 15D

PINBOARD



Use a Corkboard or Pinboard to display notes, reminders and photos, keeping your workstation free of clutter.

Concealed Corner Fixings

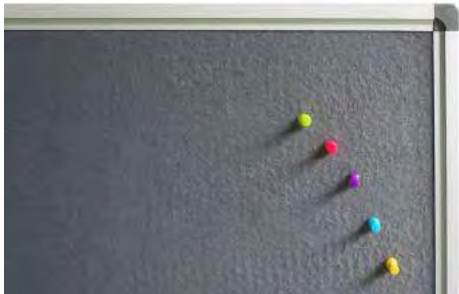

PINBOARD · Wall Mounted Pinboard with Concealed Corner Fixing, in Blue or Grey Fabric

- | | | |
|--|--|--|
| PIN96 GR · 900W x 600H x 15D · Grey | PIN96 BL · 900W x 600H x 15D Blue | PIN129 GR · 1200W x 900H x 15D · Grey |
| PIN129 BL · 1200W x 900H x 15D · Blue | PIN1212 GR · 1200W x 1200H x 15D · Grey | PIN1212 BL · 1200W x 1200H x 15D · Blue |
| PIN159 GR · 1500W x 900H x 15D · Grey | PIN159 BL · 1500W x 900H x 15D · Blue | PIN1512 GR · 1500W x 1200H x 15D · Grey |
| PIN1512 BL · 1500W x 1200H x 15D · Blue | PIN189 GR · 1800W x 900H x 15D · Grey | PIN189 BL · 1800W x 900H x 15D · Blue |
| PIN1812 GR · 1800W x 1200H x 15D · Grey | PIN1812 BL · 1800W x 1200H x 15D · Blue | PIN2412 GR · 2400W x 1200H x 15D · Grey |
| PIN2412 BL · 2400W x 1200H x 15D · Blue | | |

CORKBOARD

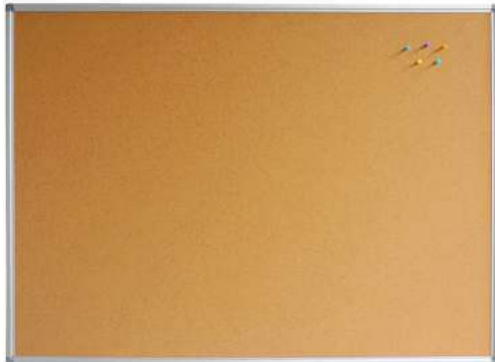

CORKBOARD · Composite Corkboard with Aluminium Frame, Suitable for Pins or Stickers

- | | |
|------------------------------------|------------------------------------|
| C96 · 900W x 600H x 15D | C129 · 1200W x 900H x 15D |
| C1212 · 1200W x 1200H x 15D | C159 · 1500W x 900H x 15D |
| C1512 · 1500W x 1200H x 15D | C189 · 1800W x 900H x 15D |
| C1812 · 1800W x 1200H x 15D | C2412 · 2400W x 1200H x 15D |

PERSONAL STORAGE

SLIMLINE MOBILE PEDESTAL



SLIMLINE MOBILE PEDESTAL · Ideal for Smaller Workstations to Allow For Extra Leg Room
Available in White China Only.
GSP3 · 3 Drawers · 300mm W x 472mm D x 610mm H

ETERNITY SLIMLINE PEDESTAL



ETERNITY SLIMLINE MOBILE PEDESTAL · White and Black Powdercoated Steel · Perfect with Rapid Infinity & Paramount Ranges
EMP3 WB · 3 Drawers · 300mm W x 535mm D x 580mm

The Rapidline under desk storage range provides convenience, security and durability with ball-bearing drawer suspension, robust steel construction and fifth wheel for stability.



MOBILE PEDESTAL



MOBILE PEDESTAL · Rapidline Mobile Pedestal, Lockable with Full Extension Ball Bearing Runners, Flush Drawer Front, Fifth Wheel for Stability
GMP3 · 3 Drawers · 460mm W x 472mm D x 610mm H

MOBILE CADDY



RAPIDLINE MOBILE CADDY · Flush Front Mobile Pedestal and Tambour Door Section with Centre Shelf, Fully Lockable and Mobile, Ideal for Hot Desks or as Workstation Return
Upholstered Seat Cushion Available (Lead Time Applies)
GCAD L · Tambour Door Left Hand · 1050mm W x 460mm D x 570mm H
GCAD R · Tambour Door Right Hand · 1050mm W x 460mm D x 570mm H

GO STEEL FILING CABINETS



GO STEEL FILING CABINETS

Heavy Duty Filing Cabinets
Fully Riveted with Ball Bearing Runners
Tested to AFRDI Level 6
40+ KG Weight Capacity per Drawer

GFCA2 · 460mm W x 620mm D x 705mm H

GFCA3 · 460mm W x 620mm D x 1016mm H

GFCA4 · 460mm W x 620mm D x 1321mm H



2 DRAWER LATERAL FILING CABINET



GO STEEL LATERAL FILING CABINETS

GLF2 · 2 DRAWER · 900mm W x 473mm D x 705mm H

GLF3 · 3 DRAWER · 900mm W x 473mm D x 1016mm H

GLF4 · 4 DRAWER · 900mm W x 473mm D x 1321mm H



OFFICE LOCKERS



OFFICE LOCKERS

Space Efficient Storage System for Use within any Office Space. 6 Lockers per Unit
Each Lockable Compartment Features a Removeable Shelf and Mail Slot on Door.

OFFICE LOCKER

800mm W x 486mm D x 1375mm H

White China



TAMBOUR DOOR CUPBOARDS



TAMBOUR DOOR CUPBOARD



TAMBOUR DOOR CUPBOARD · Tambour Door Cupboards with Easy Glide Track and Magnetic Anti Slam Rail Which Keeps Door Closed, Fully Riveted for Extra Strength, Locking with 2 Keys (Master Series), Adjustable Feet, Shelves Sold Separately

- GTD109 · 900mm W x 473mm D x 1016mm H
- GTD129 · 900mm W x 473mm D x 1200mm H
- GTD199 · 900mm W x 473mm D x 1981mm H
- GTD1012 · 1200mm W x 473mm D x 1016mm H
- GTD1212 · 1200mm W x 473mm D x 1200mm H
- GTD1912 · 1200mm W x 473mm D x 1981mm H



Tambour Door Cupboards and Accessories
Space saving storage.

ACCESSORIES



SLOTTED SHELF & DIVIDERS
GG09SLOT 900W
GG12SLOT 1200W
GS7D 5 Dividers



CLIP ON DIVIDERS
GSD6 175H



PLANTER BOX
PB 900 900W X 470D X 230H
PB 1200 1200W X 470D X 230H



PLAIN SHELF
GTD900 900W
GTD1200 1200W



PULL OUT SHELF
GG09PS 900W
GG12PS 1200W



ROLL OUT FILING FRAME
GG09FF 900W
GG12FF 1200W

GO CUPBOARD



White China

Silver Grey

Graphite Ripple



Steel Storage Range

Declutter your office space and archive like a professional.

GO CUPBOARD · Flush Lock with 2 Keys, Tested to British Standards, Assembled or Flat Pack
GCA10 · 2 Shelves · 910mm W x 450mm D x 1015mm H **GCA18** · 3 Shelves · 910mm W x 450mm D x 1830mm H
GCA20 · 4 Shelves · 910mm W x 450mm D x 2000mm H **GCWSG** · Shelf and Coat Rail Optional Extra

RAPIDLINE SHELVING UNIT



Silver Grey

RAPIDLINE SHELVING UNIT · Flat Packed, Easy to Assemble Shelving Unit, Includes 5 Shelves
GSC9422 · 910mm W x 400mm D x 2200mm H

RAPIDLINE BOLTLESS SHELVING



Silver Grey

RAPIDLINE BOLTLESS · Heavy Duty Shelving Unit
GV189 · 914mm W x 457mm D x 1830mm H
GV1812 · 1220mm W x 457mm D x 1830mm H

GO STEEL WARDROBE



Silver Grey

GO STEEL WARDROBE · Hanging Rail with 3 Shelves
 Creating 4 Other Storage Compartments, Lockable
GWA18 · 910mm W x 450mm D x 1830mm H



GO GLIDE MOBILE STORAGE SYSTEM

Make maximum use of your floor space with 3 standard lengths or customise length to fit your space.

4 BAY MOBILE SHELVING



MOBILE SHELVING · Space Efficient Method of Bulk Storage, Easy to Level and Relocate, 110kg Shelf Capacity, White Powdercoat Finish, Lockable, Available in Two Different Widths with 4 Adjustable Shelves

- 4 BAY · 2670mm L x 980mm W x 2150mm H
- 2670mm L x 1280mm W x 2150mm H

6 BAY MOBILE SHELVING



- 6 BAY · 3560mm L x 980mm W x 2150mm H
- 3560mm L x 1280mm W x 2150mm H

White China



8 BAY MOBILE SHELVING



- 8 BAY · 4450mm L x 980mm W x 2150mm H
- 4450mm L x 1280mm W x 2150mm H



BUTTERFLY LOCK

BUTTERFLY
 · GO Butterfly Lock with Padlock Facility (Padlock Not Included)
 · Suits All GO Locker Series



SLOPING TOP

30° SLOPING TOP
G12830 Single
G32830 Bank of 3
 · Available for 305W Lockers ONLY.

SINGLE DOOR LOCKER



SINGLE DOOR
GL305/1 305W x 455D x 1830H
GL380/1 380W x 455D x 1830H
 · 380W in Silver ONLY

· Riveted Construction for Extra Strength, Includes Vented Doors
 · Fitted with Hat Shelf and Coat Rail Storage

2 DOOR LOCKER



2 DOOR
GL305/2 305W x 455D x 1830H
GL380/2 380W x 455D x 1830H
 · 380W in Silver ONLY

· Riveted Construction for Extra Strength, Includes Vented Doors
 · Fitted with Coat Hook to Each Compartment

3 DOOR LOCKER



4 DOOR
GL305/4 305W x 455D x 1830H
GL380/4 380W x 455D x 1830H
 · 380W in Silver ONLY

· Riveted Construction for Extra Strength, Includes Vented Doors
 · Full Length Stiffeners Fitted to Each Door

STEP LOCKER



STEP LOCKER

· Allows 2 Hanging Spaces in 380W Locker
 · Available in Silver Grey ONLY.
 · 380W x 455D x 1830H
 · Vented Doors

STAND ONLY

STAND ONLY
SB2305

· Stand ONLY for Bank of 2 x 305W Lockers

SB3305

· Stand ONLY for Bank of 3 x 305W Lockers



SEAT & STAND

SEAT & STAND
S+S2305

· Seat and Stand for Bank of 2 x 305W Lockers Silver Grey ONLY.

S+S3305

· Seat and Stand for Bank of 3 x 305W Lockers Silver Grey ONLY.



BENCH SEAT

BENCH SEAT
BS1000

· 1000mm Wide Bench Seat Silver Grey ONLY.





WORKSTATIONS - FURNITURE - SEATING - STORAGE - ACCESSORIES
WWW.RAPIDLINE.COM.AU

rapidline
FURNITURE FOR TODAY